



- Electrically or pneumatically actuated valves
- With internal or external pilot air
- Sturdy and reliable

Specified types in accordance with ATEX directive for potentially explosive atmospheres

→ [www.festo.com/en/ex](http://www.festo.com/en/ex)

# Solenoid/pneumatic valves, Tiger 2000

Key features

FESTO

## General information

- A complete and comprehensive range with 5/2- and 5/3-way valves
- Poppet valve for single solenoid functions or piston spool for more complex versions with air spring, and 5/3-way valves
- Optimised for increased flow rates without increasing size
- Tubing connection threads in sizes G $\frac{1}{8}$ , G $\frac{1}{4}$ , G $\frac{3}{8}$
- Diverse and flexible, side and front mounting
- Pneumatic or electrical actuation
- Versatile electrical connection with F or V solenoid coil with minimal power consumption, can also be used with valve terminals
- Functional and timeless design, enclosed front housing

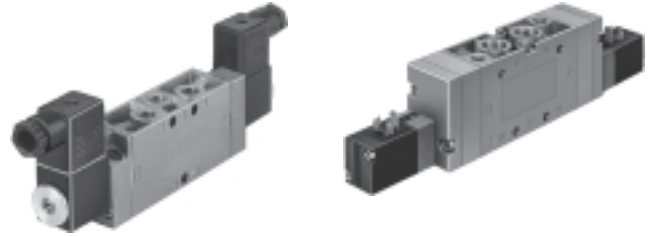

## Solenoid coils

### F solenoid coils

Voltage:

- 12 to 230 V DC
- 12 to 240 V AC (50 to 60 Hz)

Power consumption:

- 4.5 W

- For all MFH valves
- Selected types conform to the ATEX directive for explosive atmospheres  
→ [www.festo.com](http://www.festo.com)

- Easily interchangeable solenoid coils
- Solenoid coil not included in scope of delivery

### V solenoid coils

Voltage:

- 24 V DC

Power consumption:

- 2.5 W

- For all MVH valves
- Minimal heat-up

- Solenoid coil included in scope of delivery

## Manifold mounting

### With PAL manifold strip



### With PRS manifold



The Tiger 2000 valves can be mounted on PAL manifold strips with common supply port or on PRS manifolds with common supply port and common exhausts. Manifold strips and manifolds have 2 to 10 valve positions.

# Solenoid/pneumatic valves, Tiger 2000

Key features

FESTO

## Valve terminals

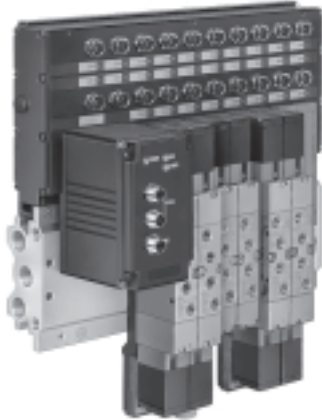

Ready to connect, completely assembled type O2 valve terminal, available with Tiger 2000 valves (V solenoid).

Connection options:

- Central multi-pin plug
- Fieldbus interface for all common fieldbus protocols
- Autonomous with integrated controller (PLC)
- For G $\frac{1}{8}$  and G $\frac{1}{4}$

## Manual override for valves with V solenoid coil

Resetting (standard)



Press on the aluminium plate

## Conversion to detenting actuation

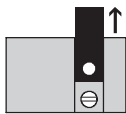

1 Pull out the aluminium plate

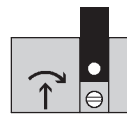

2 Using a screwdriver, simultaneously push and turn the exposed manual override

## Blocking the manual override

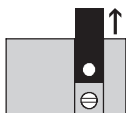

1 Pull out the aluminium plate

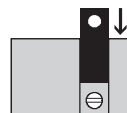

2 Rotate the aluminium plate by 180° and replace



3 The manual override is now blocked

## Pilot exhaust air for valves with V solenoid coil

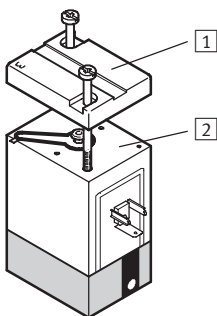

- 1 The cap may not be turned when removing the seal
- 2 Seal installed

Free pilot exhaust air Unducted by removing the seal in the top cover, the 3 on the cap must always be aligned with valve port 84 or 82.

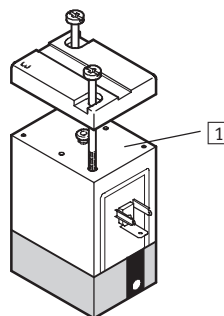

- 1 Seal removed

# Solenoid valves, Tiger 2000

Product range overview

FESTO

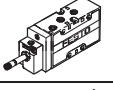
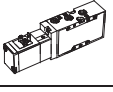
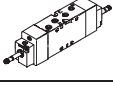
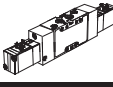
Function	Version	Type	Pneumatic connection	Operating voltage		Pilot air supply		Type of reset		→ Page/ Internet
				[V DC]	[V AC]	Internal	External	Pneumatic spring	Mechanical spring	
5/2-way valves	Solenoid valve									
		MFH	G1/8	12, 24, 42,	24, 42, 48,	■	■	■	■	11
			G1/4	48	110, 230,	■	■	■	■	
			G3/8		240	■	■	■	■	
		MVH	G1/8	24	–	■	■	■	■	29
			G1/4			■	■	■	■	
			G3/8			■	■	■	■	
	Double solenoid valve									
		JMFH	G1/8	12, 24, 42,	24, 42, 48,	■	■	–	–	18
			G1/4	48	110, 230,	■	■	–	–	
G3/8				240	■	■	–	–		
	JMVH	G1/8	24	–	■	■	–	–	35	
		G1/4			■	■	–	–		
		G3/8			■	■	–	–		

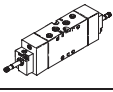
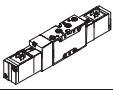
Function	Version	Type	Pneumatic connection	Operating voltage		Pilot air supply		Normal position			→ Page/ Internet
				[V DC]	[V AC]	Internal	External	Closed	Exhausted	Pressurised	
5/3-way valves	Solenoid valve										
		MFH-5/3	G1/8	12, 24,	24, 42,	■	■	■	■	■	23
			G1/4	42, 48	48, 110,	■	■	■	■	■	
			G3/8		230, 240	■	■	■	■	■	
		MVH-5/3	G1/8	24	–	■	■	■	■	■	41
			G1/4			■	■	■	■	■	
G3/8					■	■	■	■	■		

# Pneumatic valves, Tiger 2000

Product range overview

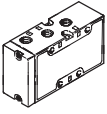
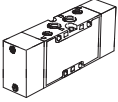
Function	Version	Type	Pneumatic connection	Type of reset		→ Page/Internet
				Pneumatic spring	Mechanical spring	
5/2-way valves	Pneumatic valve					
		VL	G1/8	-	■	49
			G1/4	-	■	
			G3/8	-	■	
	Double pilot valve					
		J	G1/8	-	-	53
G1/4			-	-		
G3/8			-	-		

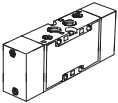
Function	Version	Type	Pneumatic connection	Normal position			→ Page/Internet
				Closed	Exhausted	Pressurised	
5/3-way valves	Pneumatic valve						
		VL	G1/8	■	■	■	56
			G1/4	■	■	■	
			G3/8	■	■	■	

# Solenoid valves, Tiger 2000

Peripherals overview

FESTO

## Mounting on manifold

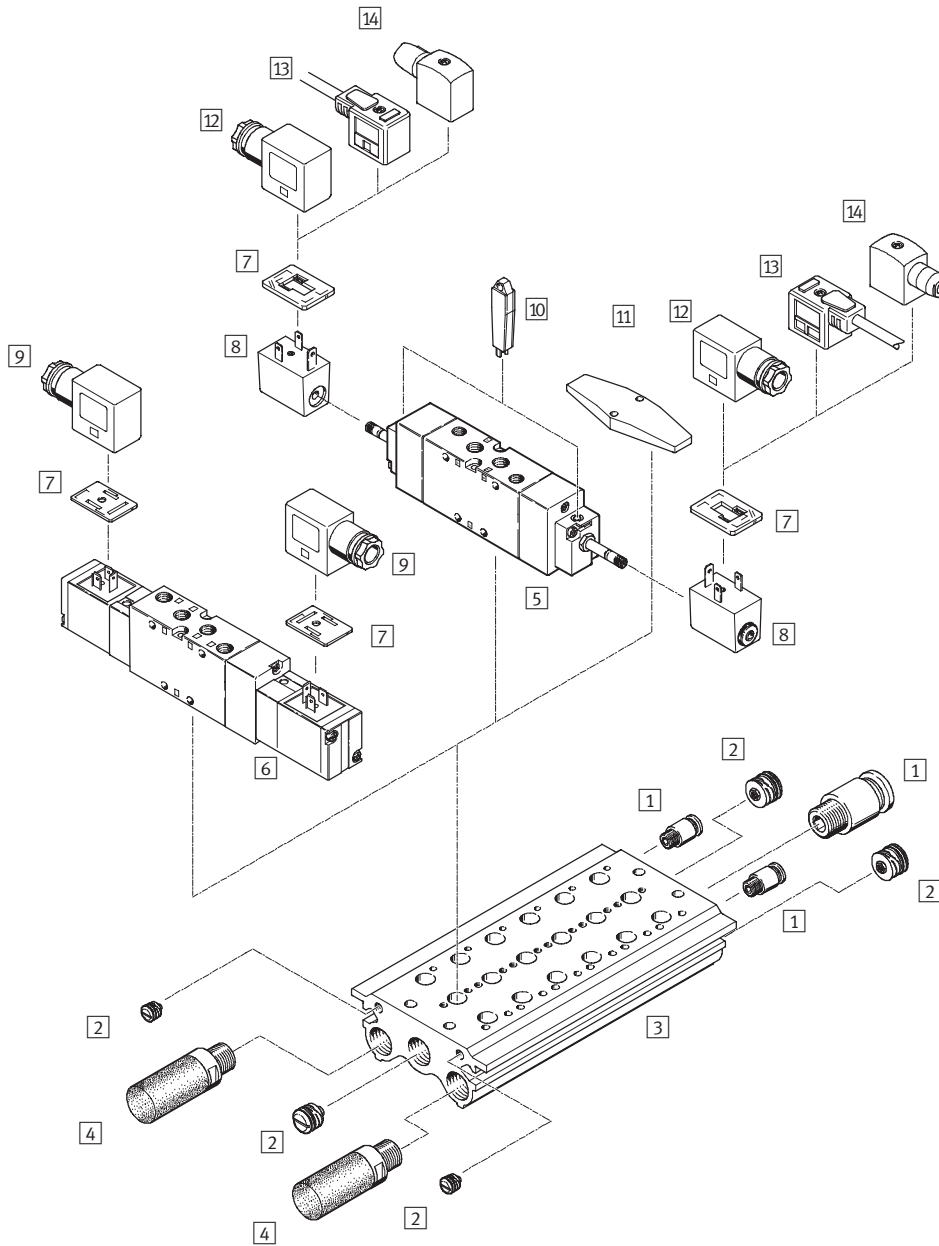

### Variants

MFH-5-...-B

MVH-5-...-B

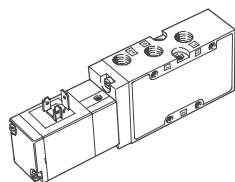
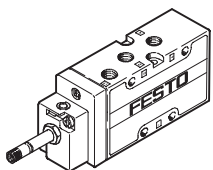

# Solenoid valves, Tiger 2000

Peripherals overview

Accessories		
	Brief description	→ Page/Internet
1	Push-in fitting QS	quick star
2	Sealing plug PRSV	64
3	Manifold PRS	62
4	Silencer	For fitting in exhaust ports u
5	Solenoid valve MFH	For F solenoid coil 4
6	Solenoid valve MVH	With V solenoid coil 4
7	Illuminating seal M...-LD	For displaying the switching status 66
8	F solenoid coil MSFG, MSFW	65
9	Plug socket MSSD-V	For valves MVH, JMVH 66
10	Manual override tool AHB	65
11	Blanking plate PRSB	For covering vacant positions 64
12	Plug socket MSSD-F	For valves MFH, JMFH 66
13	Plug socket cable KMF	For valves MFH, JMFH 66
14	Plug socket MSSD-F-S	For valves MFH, JMFH 66

# Solenoid valves, Tiger 2000

Peripherals overview

## Mounting on manifold strip

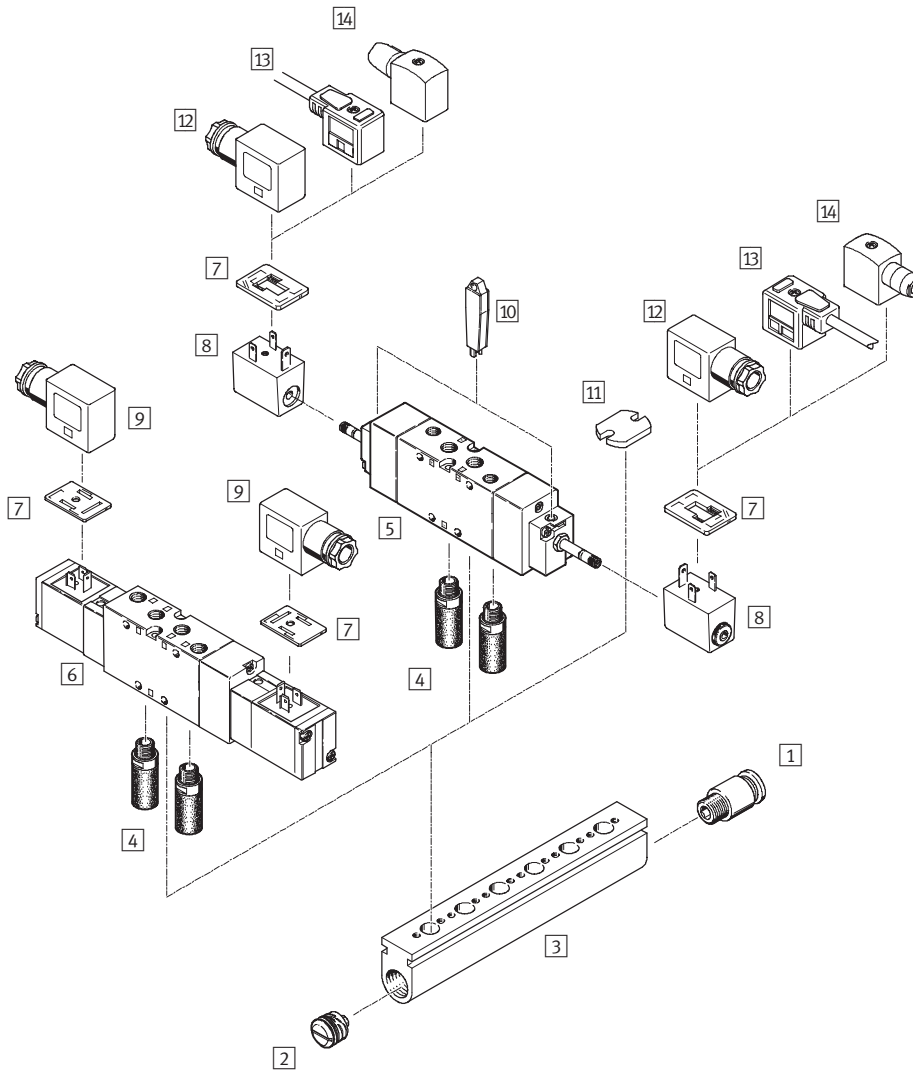

### Variants

MFH-5...-B

MVH-5...-B

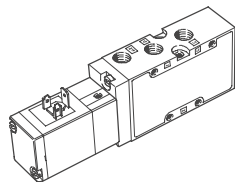
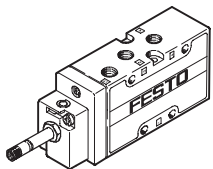



# Solenoid valves, Tiger 2000

Peripherals overview

**FESTO**

Accessories		
	Brief description	→ Page/Internet
1	Push-in fitting QS	quick star
2	Sealing plug PRSV	64
3	Manifold strip PAL	60
4	Silencer	For fitting in exhaust ports u
5	Solenoid valve MFH	For F solenoid coil 4
6	Solenoid valve MVH	With V solenoid coil 4
7	Illuminating seal M...-LD	For displaying the switching status 66
8	F solenoid coil MSFG, MSFW	For solenoid valves MFH, JMFH 65
9	Plug socket MSSD-V	For solenoid valves MVH, JMVH 66
10	Manual override tool AHB	65
11	Blanking plate PALB	For covering vacant positions 64
12	Plug socket MSSD-F	For solenoid valves MFH, JMFH 66
13	Plug socket cable KMF	For solenoid valves MFH, JMFH 66
14	Plug socket MSSD-F-S	For solenoid valves MFH, JMFH 66

# Solenoid valves, Tiger 2000

Type code

MFH - 5/3 G - 1/8 - - - B

### Type

MFH	Single solenoid, for F solenoid coil
MVH	Single solenoid, with V solenoid coil
JMFH	Double solenoid, for F solenoid coil
JMVH	Double solenoid, with V solenoid coil

### Valve function

5	5/2-way valve
5/3	5/3-way valve

### Normal position

G	Closed
E	Exhausted
B	Pressurised

### Pneumatic connection

1/8	G1/8
1/4	G1/4
3/8	G3/8

### Type of reset

	Mechanical spring
L	Pneumatic spring

### Pilot air supply

	Internal
S	External



### Generation

B	Series B
---	----------

# Solenoid valves MFH-B, Tiger 2000

Technical data – 5/2-way valves

FESTO

-  Flow rate  
750 ... 2000 l/min
  
-  Voltage  
12, 24, 42, 48 V DC  
24, 42, 48, 110, 230,  
240 V AC  
Wearing parts kits  
→ 16



General technical data						
Pneumatic connection	G $\frac{1}{8}$		G $\frac{1}{4}$		G $\frac{3}{8}$	
Type of reset	Mechanical	Pneumatic	Mechanical	Pneumatic	Mechanical	Pneumatic
Valve function	5/2-way, single solenoid					
Constructional design	Poppet	Piston spool	Poppet	Piston spool		
Sealing principle	Soft					
Actuation type	Electrical					
Type of pilot control	Piloted					
Pilot air supply	Internal or external					
Direction of flow	Non-reversible	Reversible	Non-reversible	Reversible		
Exhaust function	With flow control					
Manual override	Via accessory, detenting					
Type of mounting	Via through-holes					
Mounting position	Any					
Nominal size [mm]	5	8	7	10	12	
Standard nominal flow rate [l/min]	750	1000	1300	1600	2000	
Grid dimension [mm]	27		33		41	
Product weight [g]	220	280	300	380	630	

Operating and environmental conditions							
Pneumatic connection	G $\frac{1}{8}$		G $\frac{1}{4}$		G $\frac{3}{8}$		
Type of reset	Pneumatic	Mechanical	Pneumatic	Mechanical	Pneumatic	Mechanical	
Operating medium	Filtered compressed air, lubricated or unlubricated Vacuum						
Operating pressure	Internal pilot air supply [bar]	3 ... 10	2 ... 10	3 ... 10	2 ... 10	2 ... 10	2 ... 10
	External pilot air supply [bar]	-0.9 ... +10	0 ... 10	-0.9 ... +10	0 ... 10	-0.9 ... +10	-0.9 ... +10
Pilot pressure [bar]	3 ... 10	2 ... 10	3 ... 10	1.5 ... 10	2 ... 10	2 ... 10	
Ambient temperature [°C]	-5 ... +40						
Temperature of medium [°C]	-10 ... +60						

# Solenoid valves MFH-B, Tiger 2000

Technical data – 5/2-way valves

FESTO

## Minimum pilot pressure $p_{12}$ , $p_{14}$ as a function of the operating pressure $p_1$ (external pilot air supply)

MFH-5-1/8-S-B

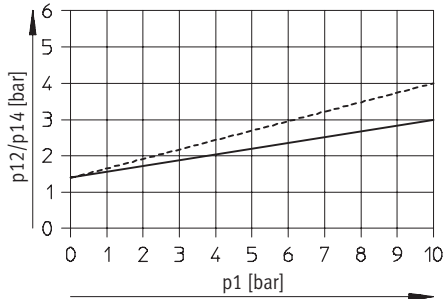

----- Exhaust throttled  
 ———— Exhaust unthrottled

MFH-5-1/4-S-B

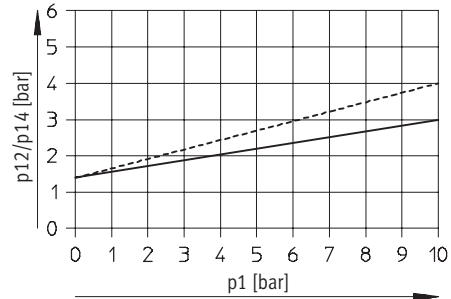

----- Exhaust throttled  
 ———— Exhaust unthrottled

MFH-5-3/8-S-B

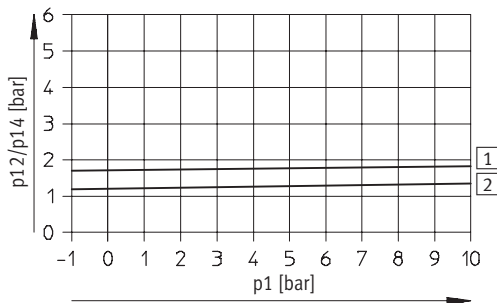

1 On  
 2 Off

## Valve response times [ms]

Pneumatic connection	G1/8		G1/4		G3/8	
Type of reset	Pneumatic	Mechanical	Pneumatic	Mechanical	Pneumatic	Mechanical
On	10	10	25	12	28	20
Off	30	30	44	36	55	56

# Solenoid valves MFH-B, Tiger 2000

Technical data – 5/2-way valves

Electrical data			
F solenoid coil			
Electrical connection		Plug vanes for plug sockets MSSD-F, KMF	
Operating voltage	D.C. voltage	[V DC]	12, 24, 42, 48
	A.C. voltage	[V AC]	24, 42, 48, 110, 230, 240 (50 ... 60 Hz)
Coil characteristics	D.C. voltage	[W]	4.5
	A.C. voltage	[VA]	Pull: 7.5 Hold: 6
Protection class to EN 60 529		IP65 (in combination with plug socket)	

## Materials

Sectional view

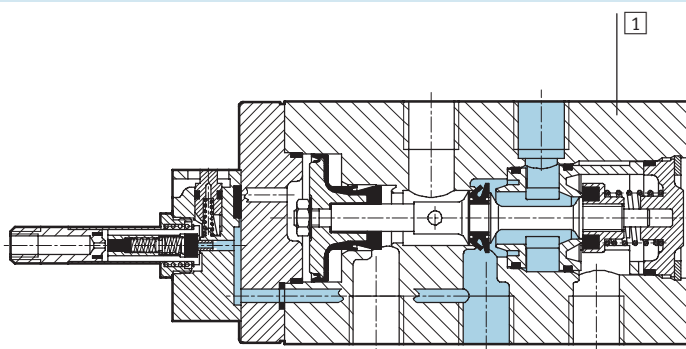

1	Housing	Die-cast aluminium
-	Seals	Nitrile rubber

# Solenoid valves MFH-B, Tiger 2000

Technical data – 5/2-way valves



## Dimensions – Pneumatic connection G<sup>1</sup>/<sub>8</sub>, G<sup>1</sup>/<sub>4</sub>

Download CAD data → [www.festo.com](http://www.festo.com)

Basic valve

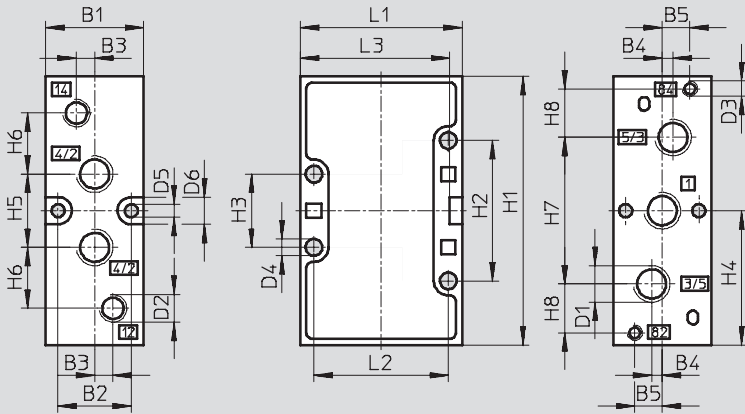

## Installation dimensions with F solenoid coil

Mechanical reset

Pneumatic reset

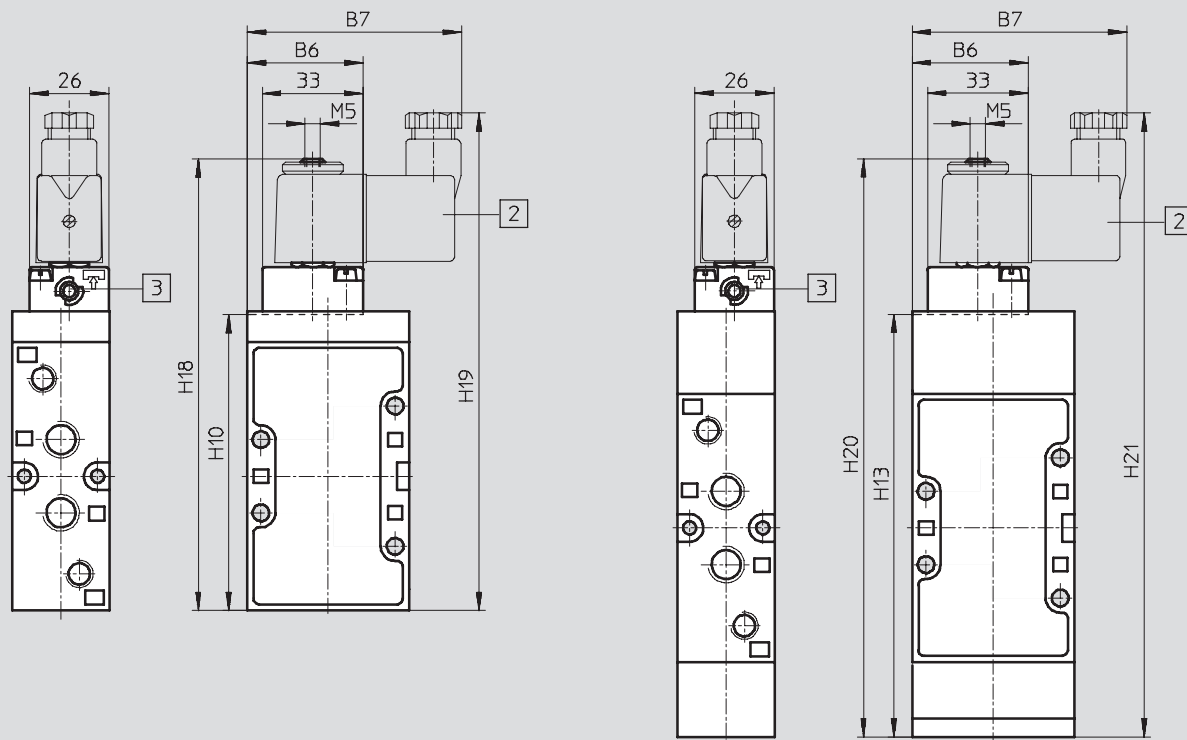

2 Solenoid coil is 360° rotatable

3 Manual override can be repositioned by 180°

Pneumatic connection	B1	B2	B3	B4	B5	B6	B7	D1	D2	D3	D4	D5	D6	H1	H2
G <sup>1</sup> / <sub>8</sub>	26	19.5	5	3.5	8	36.8	67	G <sup>1</sup> / <sub>8</sub>	G <sup>1</sup> / <sub>8</sub>	M5	4.5	4.3	9	77	41
G <sup>1</sup> / <sub>4</sub>	32	24	6	3.5	9	38	70	G <sup>1</sup> / <sub>4</sub>	G <sup>1</sup> / <sub>8</sub>	M5	5.5	4.3	9	88	46

Pneumatic connection	H3	H4	H5	H6	H7	H8	H10	H13	H18	H19	H20	H21	L1	L2	L3
G <sup>1</sup> / <sub>8</sub>	21	38.5	22	19	42	12	86.5	126.2	136	152	175	192	47	40	43
G <sup>1</sup> / <sub>4</sub>	24	44	24	20	48	16	97.5	139	147	163	188	205	53	44	49

# Solenoid valves MFH-B, Tiger 2000

Technical data – 5/2-way valves

## Dimensions – Pneumatic connection G $\frac{3}{8}$

Download CAD data → [www.festo.com](http://www.festo.com)

### Basic valve

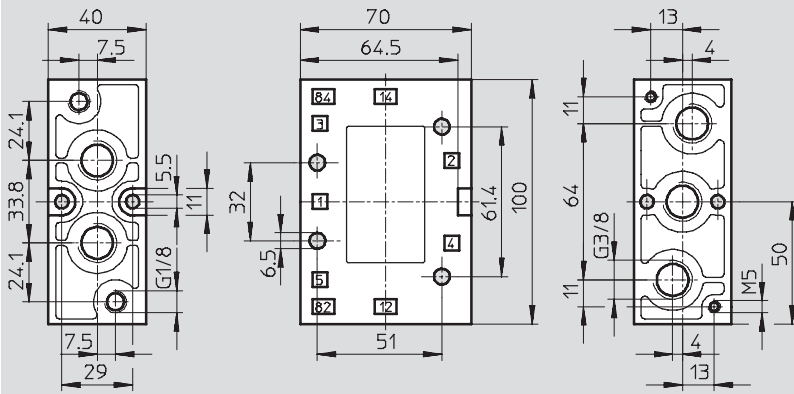

### Installation dimensions with F solenoid coil

#### Mechanical or pneumatic reset

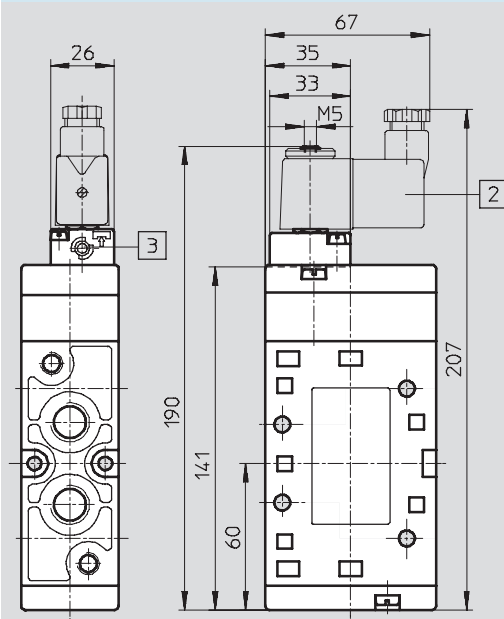

- 2 Solenoid coil is 360° rotatable
- 3 Manual override can be repositioned by 180°

# Solenoid valves MFH-B, Tiger 2000

Technical data – 5/2-way valves

Ordering data				
Circuit symbol	Description	Pneumatic connection	Part No.	Type
	Without F solenoid coil <sup>1)</sup> , pneumatic reset, internal pilot air supply	G $\frac{1}{8}$	<b>30 991</b>	<b>MFH-5-1/8-L-B</b>
		G $\frac{1}{4}$	<b>31 010</b>	<b>MFH-5-1/4-L-B</b>
		G $\frac{3}{8}$	<b>14 946</b>	<b>MFH-5-3/8-L-B</b>
	Without F solenoid coil <sup>1)</sup> , pneumatic reset, external pilot air supply	G $\frac{1}{8}$	<b>30 992</b>	<b>MFH-5-1/8-L-S-B</b>
		G $\frac{1}{4}$	<b>33 185</b>	<b>MFH-5-1/4-L-S-B</b>
		G $\frac{3}{8}$	<b>33 181</b>	<b>MFH-5-3/8-L-S-B</b>
	Without F solenoid coil <sup>1)</sup> , mechanical reset, internal pilot air supply	G $\frac{1}{8}$	<b>19 758</b>	<b>MFH-5-1/8-B</b>
		G $\frac{1}{4}$	<b>15 901</b>	<b>MFH-5-1/4-B</b>
		G $\frac{3}{8}$	<b>19 705</b>	<b>MFH-5-3/8-B</b>
	Without F solenoid coil <sup>1)</sup> , mechanical reset, external pilot air supply	G $\frac{1}{8}$	<b>19 759</b>	<b>MFH-5-1/8-S-B</b>
		G $\frac{1}{4}$	<b>15 902</b>	<b>MFH-5-1/4-S-B</b>
	Without F solenoid coil <sup>1)</sup> , mechanical reset, external pilot air supply	G $\frac{3}{8}$	<b>19 706</b>	<b>MFH-5-3/8-S-B</b>

1) F solenoid coils → 65



Ordering data – Wearing parts kits		
Pneumatic connection	Part No.	Type
G $\frac{1}{8}$	<b>125 710</b>	<b>MFH-5-1/8-B</b>
G $\frac{1}{4}$	<b>115 580</b>	<b>MFH-5-1/4-B</b>
G $\frac{3}{8}$	<b>115 074</b>	<b>MFH-5-3/8-B</b>



# Solenoid valves JMFH-B, Tiger 2000

Technical data – 5/2-way valves, double solenoid

FESTO

-  - Flow rate  
1000 ... 2000 l/min
-  - Voltage  
12, 24, 42, 48 V DC  
24, 42, 48, 110, 230,  
240 V AC

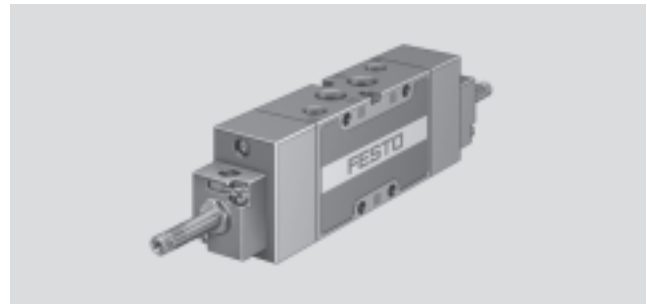

General technical data				
Pneumatic connection	G $\frac{1}{8}$	G $\frac{1}{4}$	G $\frac{3}{8}$	
Valve function	5/2-way, double solenoid			
Constructional design	Piston spool			
Sealing principle	Soft			
Actuation type	Electrical			
Type of pilot control	Piloted			
Pilot air supply	Internal or external			
Direction of flow	Non-reversible			
Exhaust function	With flow control			
Manual override	Via accessory, detenting			
Type of mounting	Via through-holes			
Mounting position	Any			
Nominal size	[mm]	8	10	12
Standard nominal flow rate	[l/min]	1000	1600	2000
Grid dimension	[mm]	27	33	41
Product weight	[g]	400	460	650

Operating and environmental conditions				
Pneumatic connection	G $\frac{1}{8}$	G $\frac{1}{4}$	G $\frac{3}{8}$	
Operating medium	Filtered compressed air, lubricated or unlubricated Vacuum			
Operating pressure	Internal pilot air supply	[bar]	2 ... 10	
	External pilot air supply	[bar]	-0.9 ... +10	
Pilot pressure	[bar]	2 ... 10		
Ambient temperature	[°C]	-5 ... +40		
Temperature of medium	[°C]	-10 ... +60		

# Solenoid valves JMFH-B, Tiger 2000

Technical data – 5/2-way valves, double solenoid

## Minimum pilot pressure $p_{12}/p_{14}$ as a function of the operating pressure $p_1$ (external pilot air supply)

JMFH-5- $\frac{1}{8}$ -S-B

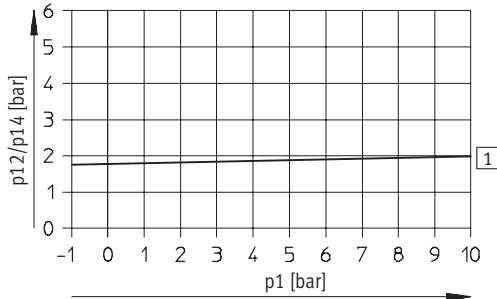

1 On

JMFH-5- $\frac{1}{4}$ -S-B

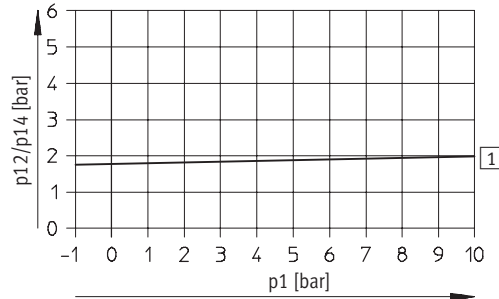

1 On

JMFH-5- $\frac{3}{8}$ -S-B

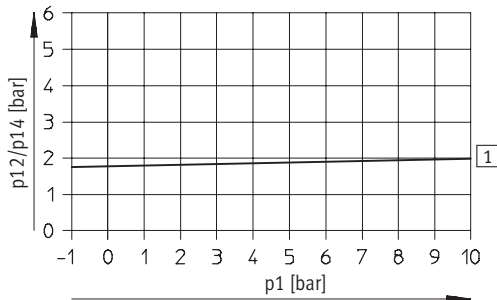

1 On

## Valve response times [ms]

Pneumatic connection	G $\frac{1}{8}$	G $\frac{1}{4}$	G $\frac{3}{8}$
Changeover	12	14	12

## Electrical data

F solenoid coil			
Electrical connection	Plug vanes for plug sockets MSSD-F, KMF		
Operating voltage	D.C. voltage	[V DC]	12, 24, 42, 48
	A.C. voltage	[V AC]	24, 42, 48, 110, 230, 240 (50 ... 60 Hz)
Coil characteristics	D.C. voltage	[W]	4.5
	A.C. voltage	[VA]	Pull: 7.5 Hold: 6
Protection class to EN 60 529	IP65 (in combination with plug socket)		

# Solenoid valves JMFH-B, Tiger 2000

Technical data – 5/2-way valves, double solenoid

## Materials

Sectional view

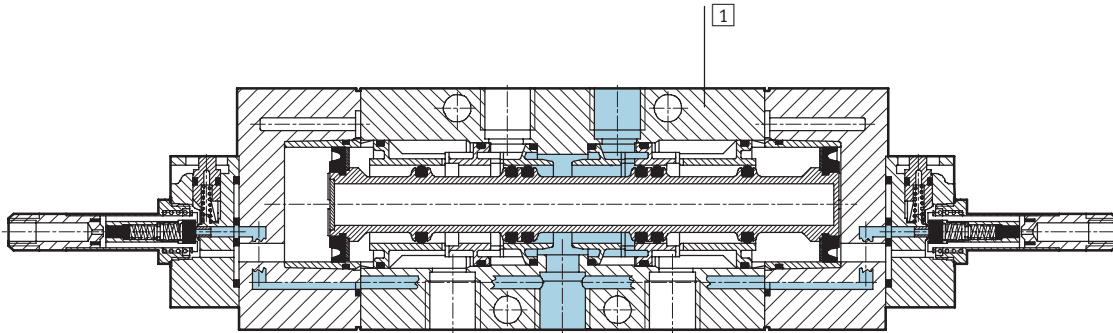

1	Housing	Die-cast aluminium
-	Seals	Nitrile rubber

# Solenoid valves JMFH-B, Tiger 2000

Technical data – 5/2-way valves, double solenoid



## Dimensions – Pneumatic connection G<sup>1</sup>/<sub>8</sub>, G<sup>1</sup>/<sub>4</sub>

Download CAD data → [www.festo.com](http://www.festo.com)

Basic valve

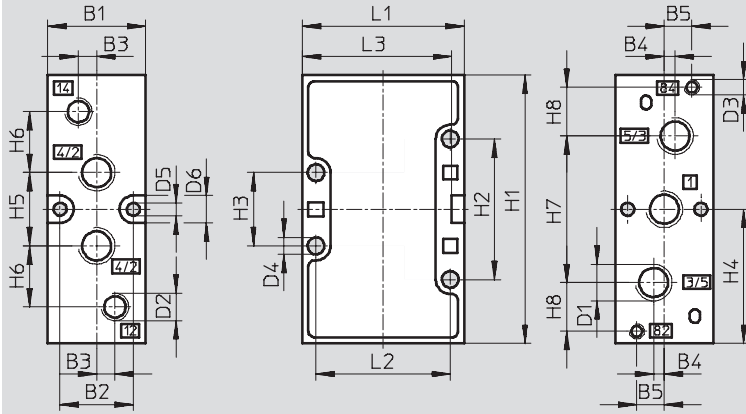

## Installation dimensions with F solenoid coil, mechanical or pneumatic reset

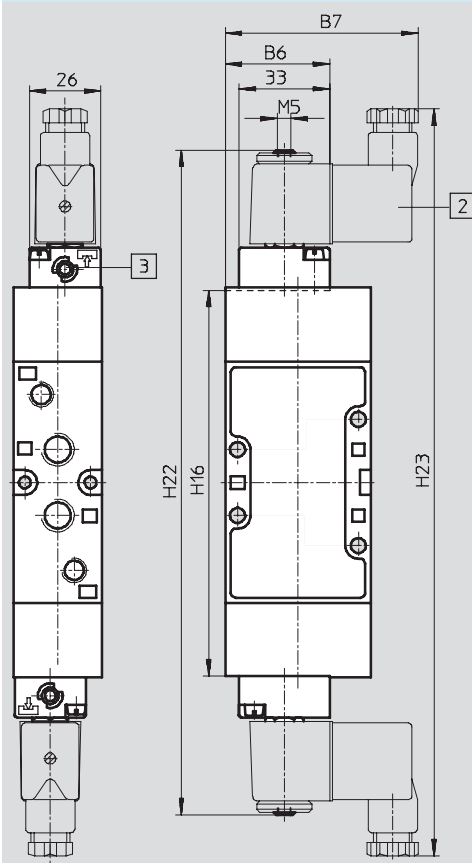

- 2 Solenoid coil is 360° rotatable
- 3 Manual override can be repositioned by 180°

Pneumatic connection	B1	B2	B3	B4	B5	B6	B7	D1	D2	D3	D4	D5	D6	H1
G <sup>1</sup> / <sub>8</sub>	26	19.5	5	3.5	8	36.8	67	G <sup>1</sup> / <sub>8</sub>	G <sup>1</sup> / <sub>8</sub>	M5	4.5	4.3	9	77
G <sup>1</sup> / <sub>4</sub>	32	24	6	3.5	9	38	70	G <sup>1</sup> / <sub>4</sub>	G <sup>1</sup> / <sub>8</sub>	M5	5.5	4.3	9	88

Pneumatic connection	H2	H3	H4	H5	H6	H7	H8	H16	H22	H23	L1	L2	L3
G <sup>1</sup> / <sub>8</sub>	41	21	38.5	22	19	42	12	129	227	260	47	40	43
G <sup>1</sup> / <sub>4</sub>	46	24	44	24	20	48	16	141.5	240	273	53	44	49

# Solenoid valves JMFH-B, Tiger 2000

Technical data – 5/2-way valves, double solenoid

## Dimensions – Pneumatic connection G<sup>3</sup>/<sub>8</sub>

Download CAD data → [www.festo.com](http://www.festo.com)

Basic valve

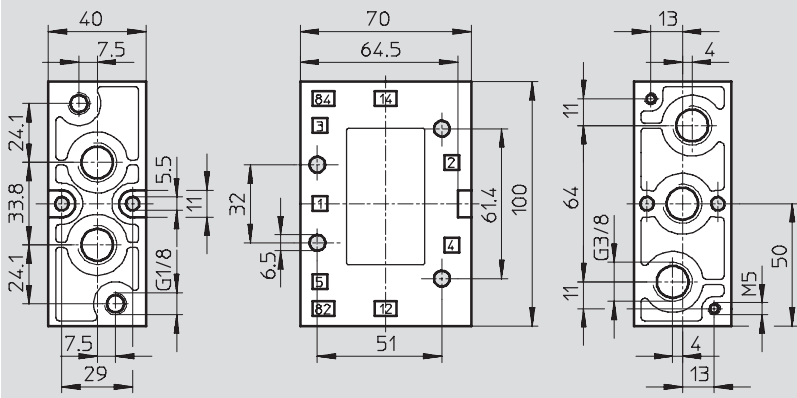

## Installation dimensions with F solenoid coil, mechanical or pneumatic reset

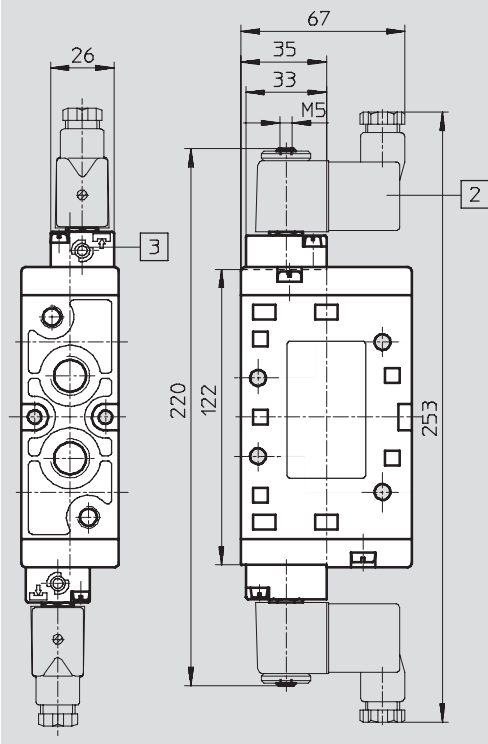

- 2 Solenoid coil is 360° rotatable
- 3 Manual override can be repositioned by 180°

# Solenoid valves JMFH-B, Tiger 2000



Technical data – 5/2-way valves, double solenoid

Ordering data				
Circuit symbol	Description	Pneumatic connection	Part No.	Type
	Without F solenoid coil <sup>1)</sup> , internal pilot air supply	G1/8	<b>30 486</b>	<b>JMFH-5-1/8-B</b>
		G1/4	<b>19 789</b>	<b>JMFH-5-1/4-B</b>
		G3/8	<b>19 700</b>	<b>JMFH-5-3/8-B</b>
	Without F solenoid coil <sup>1)</sup> , external pilot air supply	G1/8	<b>30 487</b>	<b>JMFH-5-1/8-S-B</b>
		G1/4	<b>19 790</b>	<b>JMFH-5-1/4-S-B</b>
		G3/8	<b>19 702</b>	<b>JMFH-5-3/8-S-B</b>

1) F solenoid coils → 65

# Solenoid valves MFH-B, Tiger 2000

Technical data – 5/3-way valves

-  - Flow rate  
1000 ... 2600 l/min
-  - Voltage  
12, 24, 42, 48 V DC  
24, 42, 48, 110, 230,  
240 V AC

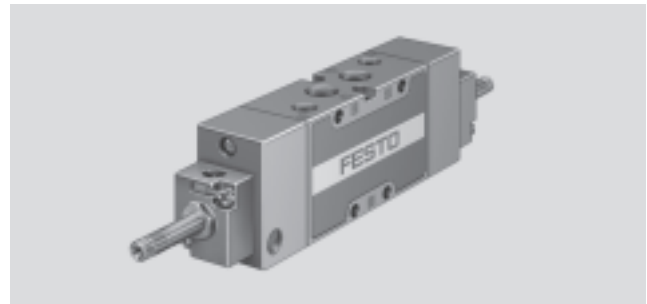

General technical data						
Pneumatic connection		G $\frac{1}{8}$	G $\frac{1}{4}$	G $\frac{3}{8}$		
Valve function		5/3-way, single solenoid				
Constructional design		Piston spool				
Sealing principle		Soft				
Actuation type		Electrical				
Type of reset		Mechanical spring				
Type of pilot control		Piloted				
Pilot air supply		Internal or external				
Direction of flow		Non-reversible				
Exhaust function		With flow control				
Manual override		Via accessory, detenting				
Type of mounting		Via through-holes				
Mounting position		Any				
Nominal size		[mm]	5	7	12	
Standard nominal flow rate	Closed	[l/min]	1000	1600	2000	
	Exhausted	[l/min]				2200
	Pressurised	[l/min]				2600
Grid dimension		[mm]	27	33	41	
Product weight		[g]	400	500	780	

Operating and environmental conditions					
Pneumatic connection		G $\frac{1}{8}$	G $\frac{1}{4}$	G $\frac{3}{8}$	
Operating medium		Filtered compressed air, lubricated or unlubricated Vacuum			
Operating pressure	Internal pilot air supply	[bar]	3 ... 10	3 ... 10	3 ... 10
	External pilot air supply	[bar]	-0.9 ... +10	-0.9 ... +10	-0.9 ... +10
Pilot pressure		[bar]	3 ... 10	3 ... 10	3 ... 10
Ambient temperature		[°C]	-5 ... +40		
Temperature of medium		[°C]	-10 ... +60		

# Solenoid valves MFH-B, Tiger 2000

Technical data – 5/3-way valves

FESTO

## Minimum pilot pressure $p_{12}/p_{14}$ as a function of the operating pressure $p_1$ (external pilot air supply)

MFH-5/3...-1/8-S-B

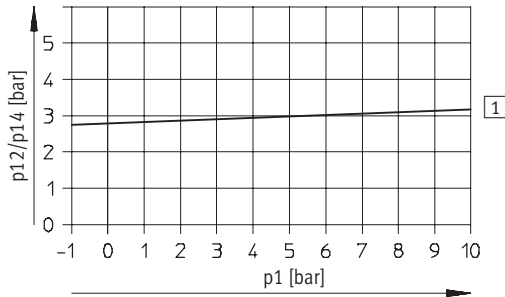

1 On

MFH-5/3...-1/4-S-B

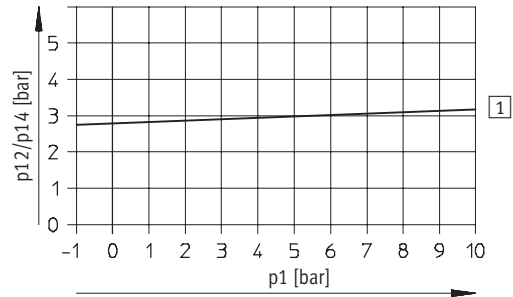

1 On

MFH-5/3...-3/8-S-B

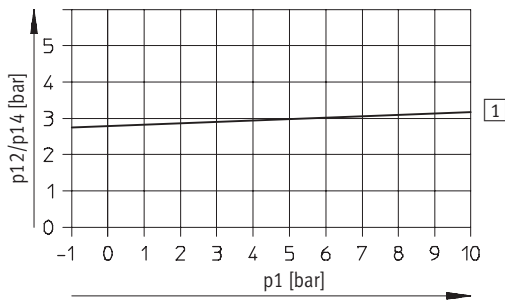

1 On

## Valve response times [ms]

Pneumatic connection	G <sup>1</sup> / <sub>8</sub>		G <sup>1</sup> / <sub>4</sub>		G <sup>3</sup> / <sub>8</sub>	
	On	Off	On	Off	On	Off
Closed	18	20	20	22	24	80
Exhausted	20	20	24	36	36	85
Pressurised	24	24	34	30	30	82



# Solenoid valves MFH-B, Tiger 2000

Technical data – 5/3-way valves

Electrical data			
F solenoid coil			
Electrical connection		Plug vanes for plug sockets MSSD-F, KMF	
Operating voltage	D.C. voltage	[V DC]	12, 24, 42, 48
	A.C. voltage	[V AC]	24, 42, 48, 110, 230, 240 (50 ... 60 Hz)
Coil characteristics	D.C. voltage	[W]	4.5
	A.C. voltage	[VA]	Pull: 7.5 Hold: 6
Protection class to EN 60 529		IP65 (in combination with plug socket)	

## Materials

Sectional view

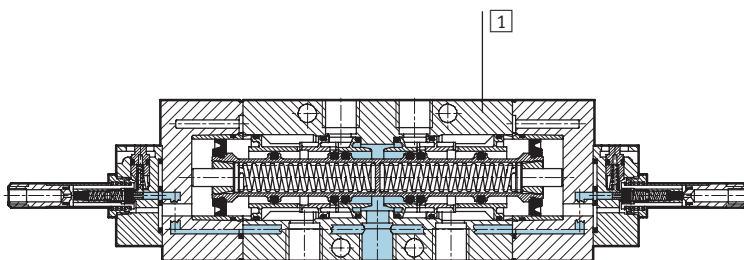

1	Housing	Die-cast aluminium
-	Seals	Nitrile rubber

# Solenoid valves MFH-B, Tiger 2000

Technical data – 5/3-way valves



## Dimensions – Pneumatic connection G<sup>1</sup>/<sub>8</sub>, G<sup>1</sup>/<sub>4</sub>

Download CAD data → [www.festo.com](http://www.festo.com)

Basic valve

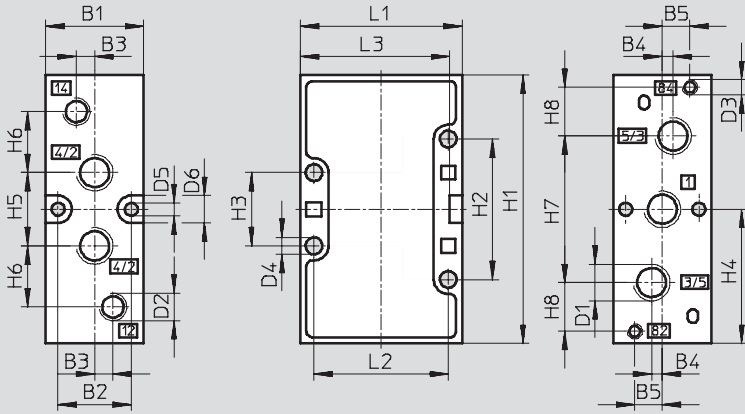

## Installation dimensions with F solenoid coil, mechanical or pneumatic reset

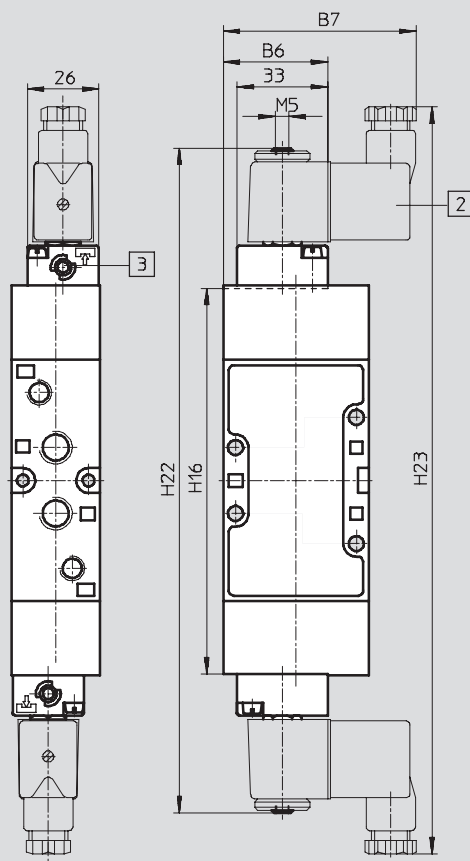

- 2 Solenoid coil is 360° rotatable
- 3 Manual override can be repositioned by 180°

Pneumatic connection	B1	B2	B3	B4	B5	B6	B7	D1	D2	D3	D4	D5	D6	H1
G <sup>1</sup> / <sub>8</sub>	26	19.5	5	3.5	8	36.8	67	G <sup>1</sup> / <sub>8</sub>	G <sup>1</sup> / <sub>8</sub>	M5	4.5	4.3	9	77
G <sup>1</sup> / <sub>4</sub>	32	24	6	3.5	9	38	70	G <sup>1</sup> / <sub>4</sub>	G <sup>1</sup> / <sub>8</sub>	M5	5.5	4.3	9	88

Pneumatic connection	H2	H3	H4	H5	H6	H7	H8	H16	H22	H23	L1	L2	L3
G <sup>1</sup> / <sub>8</sub>	41	21	38.5	22	19	42	12	129	227	260	47	40	43
G <sup>1</sup> / <sub>4</sub>	46	24	44	24	20	48	16	141.5	240	273	53	44	49

# Solenoid valves MFH-B, Tiger 2000

Technical data – 5/3-way valves

Dimensions – Pneumatic connection G $\frac{3}{8}$

Download CAD data → [www.festo.com](http://www.festo.com)

Basic valve

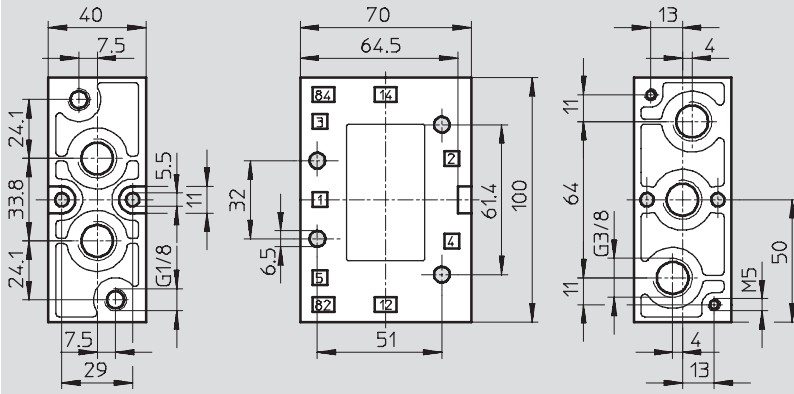

Installation dimensions with F solenoid coil, mechanical or pneumatic reset

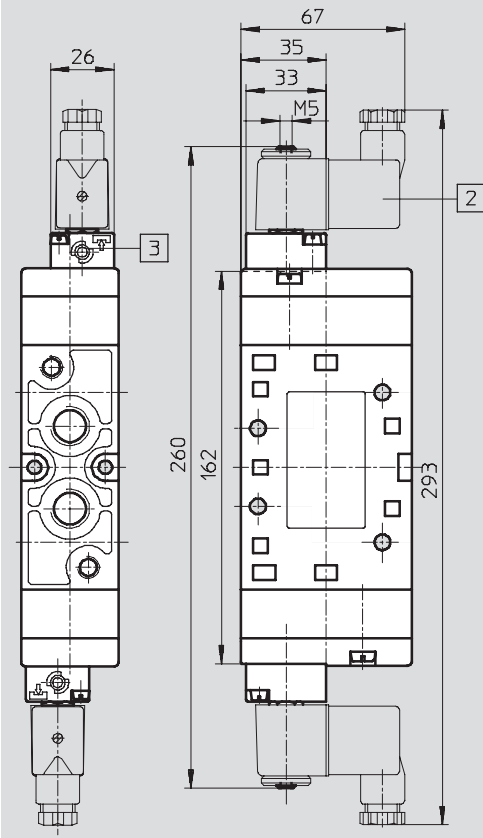

- 2 Solenoid coil is 360° rotatable
- 3 Manual override can be repositioned by 180°

# Solenoid valves MFH-B, Tiger 2000

Technical data – 5/3-way valves

Ordering data				
Circuit symbol	Description	Pneumatic connection	Part No.	Type
	Without F solenoid coil <sup>1)</sup> , normally closed, internal pilot air supply	G $\frac{1}{8}$	30 484	MFH-5/3G- $\frac{1}{8}$ -B
		G $\frac{1}{4}$	19 787	MFH-5/3G- $\frac{1}{4}$ -B
		G $\frac{3}{8}$	19 707	MFH-5/3G- $\frac{3}{8}$ -B
	Without F solenoid coil <sup>1)</sup> , normally closed, external pilot air supply	G $\frac{1}{8}$	30 993	MFH-5/3G- $\frac{1}{8}$ -S-B
		G $\frac{1}{4}$	31 001	MFH-5/3G- $\frac{1}{4}$ -S-B
		G $\frac{3}{8}$	31 317	MFH-5/3G- $\frac{3}{8}$ -S-B
	Without F solenoid coil <sup>1)</sup> , normally exhausted, internal pilot air supply	G $\frac{1}{8}$	30 483	MFH-5/3E- $\frac{1}{8}$ -B
		G $\frac{1}{4}$	19 786	MFH-5/3E- $\frac{1}{4}$ -B
		G $\frac{3}{8}$	19 708	MFH-5/3E- $\frac{3}{8}$ -B
	Without F solenoid coil <sup>1)</sup> , normally exhausted, external pilot air supply	G $\frac{1}{8}$	30 994	MFH-5/3E- $\frac{1}{8}$ -S-B
		G $\frac{1}{4}$	31 002	MFH-5/3E- $\frac{1}{4}$ -S-B
		G $\frac{3}{8}$	31 318	MFH-5/3E- $\frac{3}{8}$ -S-B
	Without F solenoid coil <sup>1)</sup> , normally pressurised, internal pilot air supply	G $\frac{1}{8}$	30 485	MFH-5/3B- $\frac{1}{8}$ -B
		G $\frac{1}{4}$	19 788	MFH-5/3B- $\frac{1}{4}$ -B
		G $\frac{3}{8}$	19 709	MFH-5/3B- $\frac{3}{8}$ -B
	Without F solenoid coil <sup>1)</sup> , normally pressurised, external pilot air supply	G $\frac{1}{8}$	30 995	MFH-5/3B- $\frac{1}{8}$ -S-B
		G $\frac{1}{4}$	31 003	MFH-5/3B- $\frac{1}{4}$ -S-B
		G $\frac{3}{8}$	31 319	MFH-5/3B- $\frac{3}{8}$ -S-B

1) F solenoid coils → 65

# Solenoid valves MVH-B, Tiger 2000

Technical data – 5/2-way valves

FESTO

-  - Flow rate  
750 ... 2000 l/min

-  - Voltage  
24 V DC

Wearing parts kits  
→ 34



General technical data								
Pneumatic connection	G $\frac{1}{8}$		G $\frac{1}{4}$		G $\frac{3}{8}$			
Type of reset	Mechanical	Pneumatic	Mechanical	Pneumatic	Mechanical	Pneumatic		
Valve function	5/2-way, single solenoid							
Constructional design	Poppet	Piston spool	Poppet	Piston spool	Piston spool			
Sealing principle	Soft							
Actuation type	Electrical							
Type of pilot control	Piloted							
Pilot air supply	Internal or external							
Direction of flow	Non-reversible							
Exhaust function	With flow control							
Manual override	Resetting, detenting, covered							
Type of mounting	Via through-holes							
Mounting position	Any							
Nominal size [mm]	5	8	7	10	12			
Standard nominal flow rate [l/min]	750	1000	1300	1600	2000			
Grid dimension [mm]	27		33			41		
Product weight [g]	230	290	360	495	750			

Operating and environmental conditions							
Pneumatic connection	G $\frac{1}{8}$		G $\frac{1}{4}$		G $\frac{3}{8}$		
Type of reset	Pneumatic	Mechanical	Pneumatic	Mechanical	Pneumatic	Mechanical	
Operating medium	Filtered compressed air, lubricated or unlubricated Vacuum						
Operating pressure	Internal pilot air supply [bar]	3 ... 10	2 ... 10	3 ... 10	2 ... 10	2 ... 10	2 ... 10
	External pilot air supply [bar]	-0.9 ... +10	0 ... 10	-0.9 ... +10	0 ... 10	-0.9 ... +10	-0.9 ... +10
Pilot pressure [bar]	3 ... 10	2 ... 10	3 ... 10	1.5 ... 10	2 ... 10	2 ... 10	
Ambient temperature [°C]	-5 ... +50						
Temperature of medium [°C]	-5 ... +50						

# Solenoid valves MVH-B, Tiger 2000

Technical data – 5/2-way valves

FESTO

## Minimum pilot pressure $p_{12}/p_{14}$ as a function of the operating pressure $p_1$ (external pilot air supply)

MVH-5-1/8-S-B

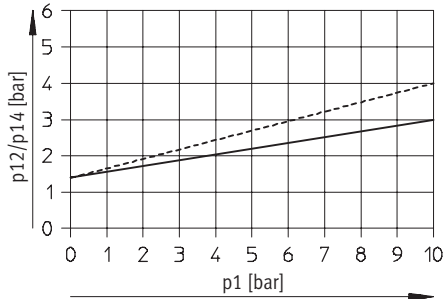

----- Exhaust throttled  
 ———— Exhaust unthrottled

MVH-5-1/4-S-B

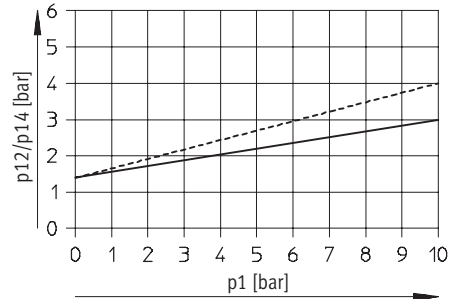

----- Exhaust throttled  
 ———— Exhaust unthrottled

MVH-5-3/8-S-B

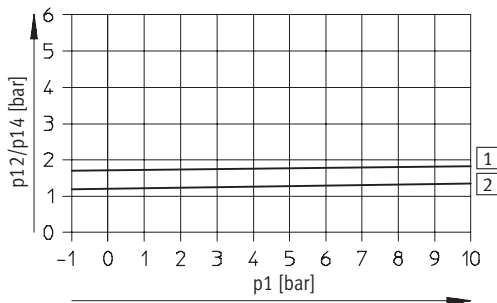

1 On  
 2 Off

## Valve response times [ms]

Pneumatic connection	G1/8		G1/4		G3/8	
Type of reset	Pneumatic	Mechanical	Pneumatic	Mechanical	Pneumatic	Mechanical
On	31	20	33	15	22	22
Off	18	36	40	36	60	60

# Solenoid valves MVH-B, Tiger 2000

Technical data – 5/2-way valves

Electrical data			
V solenoid			
Electrical connection	To DIN EN 175301-803 type B		
Operating voltage	D.C. voltage	[V DC]	24
Coil characteristics	D.C. voltage	[W]	2.5
Protection class to EN 60 529	IP65 (in combination with plug socket)		

## Materials

Sectional view

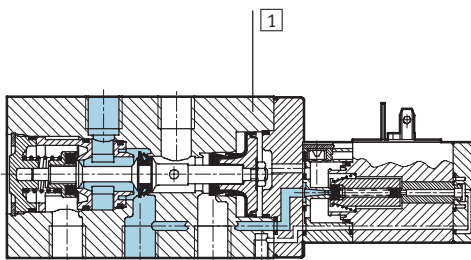

1	Housing	Die-cast aluminium, plastic
-	Seals	Nitrile rubber

# Solenoid valves MVH-B, Tiger 2000

Technical data – 5/2-way valves

FESTO

## Dimensions – Pneumatic connection G<sup>1</sup>/<sub>8</sub>, G<sup>1</sup>/<sub>4</sub>

Download CAD data → [www.festo.com](http://www.festo.com)

Basic valve

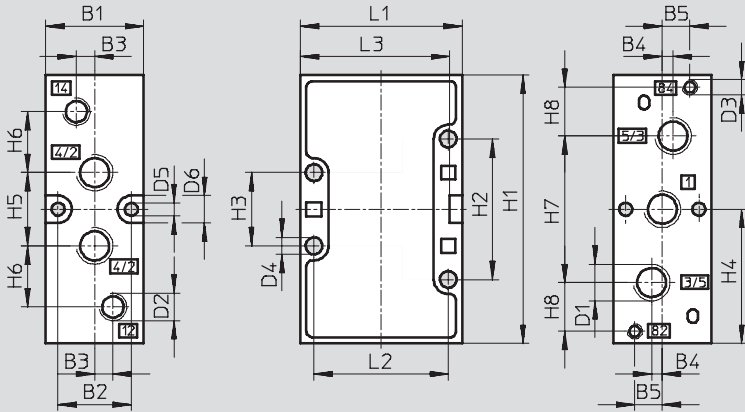

## Installation dimensions with V solenoid coil

Mechanical reset

Pneumatic reset

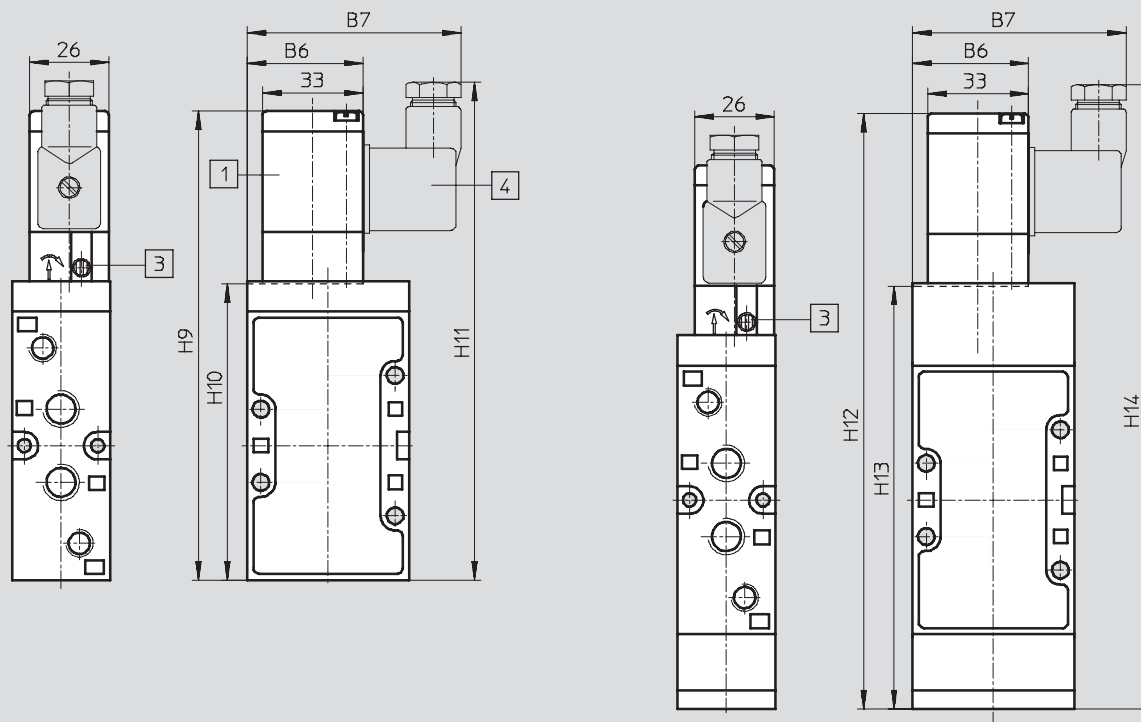

1 Solenoid coil can be repositioned by 180°

3 Manual override can be repositioned by 180°

4 Plug socket connection to EN 175301-803 type B

Pneumatic connection	B1	B2	B3	B4	B5	B6	B7	D1	D2	D3	D4	D5	D6	H1	H2	H3	H4
G <sup>1</sup> / <sub>8</sub>	26	19.5	5	3.5	8	36.8	67	G <sup>1</sup> / <sub>8</sub>	G <sup>1</sup> / <sub>8</sub>	M5	4.5	4.3	9	77	41	21	38.5
G <sup>1</sup> / <sub>4</sub>	32	24	6	3.5	9	38	70	G <sup>1</sup> / <sub>4</sub>	G <sup>1</sup> / <sub>8</sub>	M5	5.5	4.3	9	88	46	24	44

Pneumatic connection	H5	H6	H7	H8	H9	H10	H11	H12	H13	H14	H18	H19	H20	H21	L1	L2	L3
G <sup>1</sup> / <sub>8</sub>	22	19	42	12	143	86.5	153	183	126.2	193	136	152	175	192	47	40	43
G <sup>1</sup> / <sub>4</sub>	24	20	48	16	154	97.5	163	196	139	206	147	163	188	205	53	44	49



# Solenoid valves MVH-B, Tiger 2000

Technical data – 5/2-way valves

## Dimensions – Pneumatic connection G $\frac{3}{8}$

Download CAD data → [www.festo.com](http://www.festo.com)

Basic valve

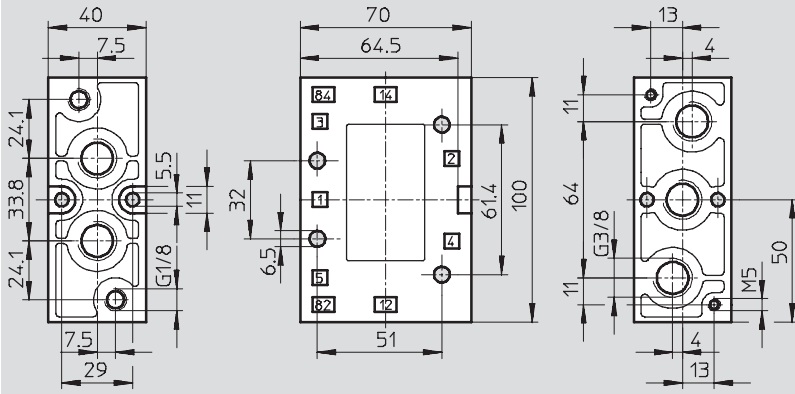

## Installation dimensions with V solenoid coil

Mechanical or pneumatic reset

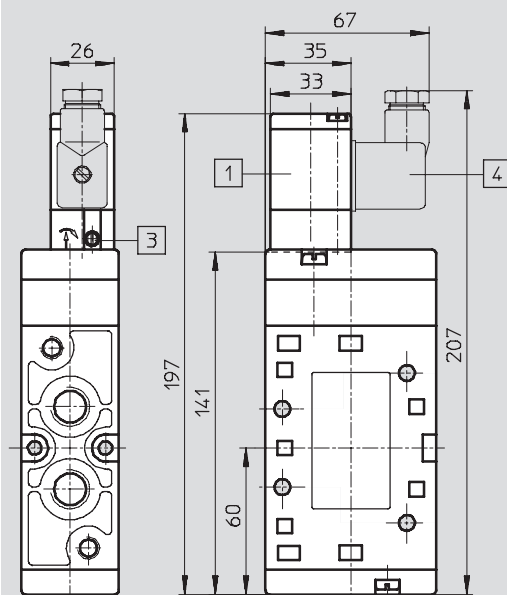

- 1 Solenoid coil is 360° rotatable
- 3 Manual override can be repositioned by 180°
- 4 Plug socket connection to EN 175301-803 type B

# Solenoid valves MVH-B, Tiger 2000

Technical data – 5/2-way valves

Ordering data					
Circuit symbol	Description	Voltage	Pneumatic connection	Part No.	Type
	With V solenoid coil, pneumatic reset, internal pilot air supply	24 V DC	G $\frac{1}{8}$	<b>19 749</b>	<b>MVH-5-1/8-L-B</b>
			G $\frac{1}{4}$	<b>31 009</b>	<b>MVH-5-1/4-L-B</b>
			G $\frac{3}{8}$	<b>14 947</b>	<b>MVH-5-3/8-L-B</b>
	With V solenoid coil, pneumatic reset, external pilot air supply	24 V DC	G $\frac{1}{8}$	<b>19 750</b>	<b>MVH-5-1/8-L-S-B</b>
			G $\frac{1}{4}$	<b>33 184</b>	<b>MVH-5-1/4-L-S-B</b>
			G $\frac{3}{8}$	<b>33 180</b>	<b>MVH-5-3/8-L-S-B</b>
	With V solenoid coil, mechanical reset, internal pilot air supply	24 V DC	G $\frac{1}{8}$	<b>19 779</b>	<b>MVH-5-1/8-B</b>
			G $\frac{1}{4}$	<b>19 701</b>	<b>MVH-5-1/4-B</b>
			G $\frac{3}{8}$	<b>14 945</b>	<b>MVH-5-3/8-B</b>
	With V solenoid coil, mechanical reset, external pilot air supply	24 V DC	G $\frac{1}{8}$	<b>30 996</b>	<b>MVH-5-1/8-S-B</b>
			G $\frac{1}{4}$	<b>15 903</b>	<b>MVH-5-1/4-S-B</b>
			G $\frac{3}{8}$	<b>15 342</b>	<b>MVH-5-3/8-S-B</b>

Ordering data – Wearing parts kits		
Pneumatic connection	Part No.	Type
G $\frac{1}{8}$	<b>125 071</b>	<b>MVH-5-1/8-B</b>
G $\frac{1}{4}$	<b>115 588</b>	<b>MVH-5-1/4-B</b>
G $\frac{3}{8}$	<b>115 074</b>	<b>MVH-5-3/8-B</b>

# Solenoid valves JMVH-B, Tiger 2000

Technical data – 5/2-way valves, double solenoid

FESTO

-  - Flow rate  
1000 ... 2000 l/min

-  - Voltage  
24 V DC

Wearing parts kits  
→ 40



General technical data			
Pneumatic connection	G $\frac{1}{8}$	G $\frac{1}{4}$	G $\frac{3}{8}$
Valve function	5/2-way, double solenoid		
Constructional design	Piston spool		
Sealing principle	Soft		
Actuation type	Electrical		
Type of pilot control	Piloted		
Pilot air supply	Internal or external		
Direction of flow	Non-reversible		
Exhaust function	With flow control		
Manual override	Resetting, detenting, covered		
Type of mounting	Via through-holes		
Mounting position	Any		
Nominal size	[mm] 5	7	12
Standard nominal flow rate	[l/min] 750	1300	2000
Grid dimension	[mm] 27	33	41
Product weight	[g] 560	615	900

Operating and environmental conditions			
Pneumatic connection	G $\frac{1}{8}$	G $\frac{1}{4}$	G $\frac{3}{8}$
Operating medium	Filtered compressed air, lubricated or unlubricated Vacuum		
Operating pressure	Internal pilot air supply [bar] 2 ... 10	2 ... 10	2 ... 10
	External pilot air supply [bar] -0.9 ... +10	-0.9 ... +10	-0.9 ... +10
Pilot pressure	[bar] 2 ... 10	2 ... 10	2 ... 10
Ambient temperature	[°C] -5 ... +50		
Temperature of medium	[°C] -5 ... +50		

# Solenoid valves JMVH-B, Tiger 2000

Technical data – 5/2-way valves, double solenoid

FESTO

## Minimum pilot pressure $p_{12}/p_{14}$ as a function of the operating pressure $p_1$ (external pilot air supply)

JMVH-5-1/8-S-B

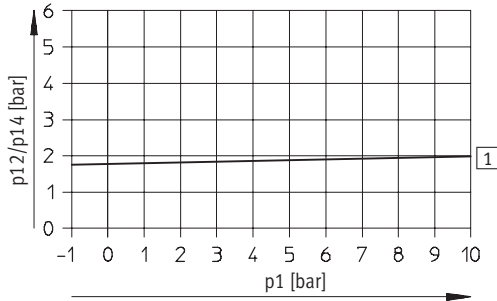

1 On

JMVH-5-1/4-S-B

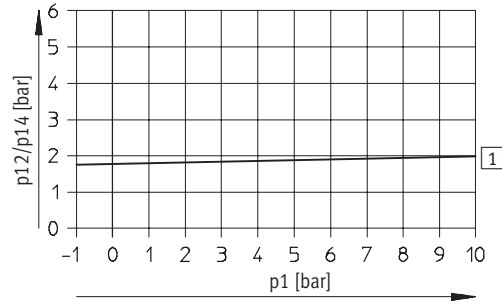

1 On

JMVH-5-3/8-S-B

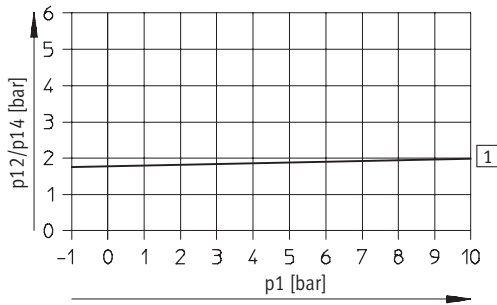

1 On

## Valve response times [ms]

Pneumatic connection	G1/8	G1/4	G3/8
Changeover	18	16	17

# Solenoid valves JMVH-B, Tiger 2000

Technical data – 5/2-way valves, double solenoid

Electrical data			
V solenoid			
Electrical connection		To DIN EN 175301-803 type B	
Operating voltage	D.C. voltage	[V DC]	24
Coil characteristics	D.C. voltage	[W]	2.5
Protection class to EN 60 529		IP65 (in combination with plug socket)	

## Materials

Sectional view

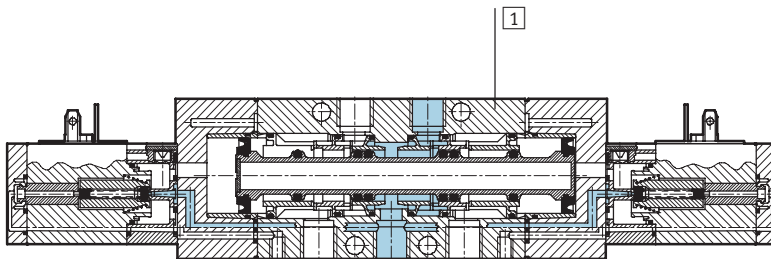

1	Housing	Die-cast aluminium, plastic
-	Seals	Nitrile rubber

# Solenoid valves JMVH-B, Tiger 2000

Technical data – 5/2-way valves, double solenoid



## Dimensions – Pneumatic connection G<sup>1</sup>/<sub>8</sub>, G<sup>1</sup>/<sub>4</sub>

Download CAD data → [www.festo.com](http://www.festo.com)

Basic valve

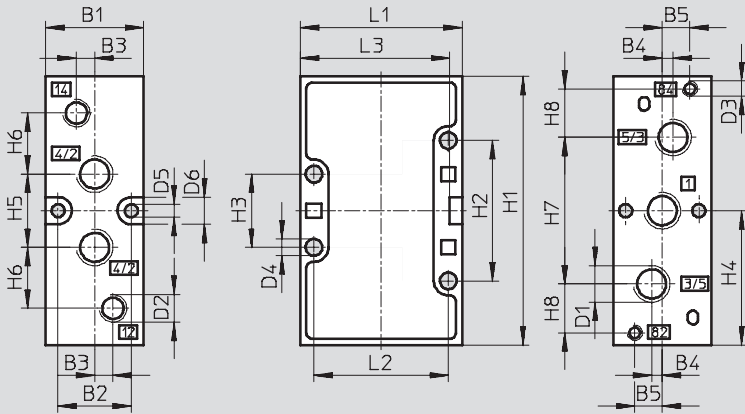

## Installation dimensions with V solenoid coil, mechanical or pneumatic reset

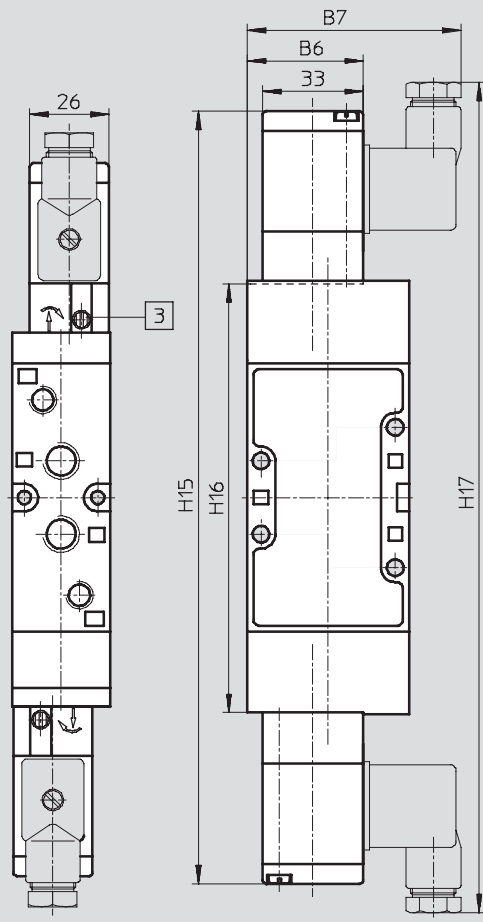

3 Manual override can be repositioned by 180°

Pneumatic connection	B1	B2	B3	B4	B5	B6	B7	D1	D2	D3	D4	D5	D6	H1
G <sup>1</sup> / <sub>8</sub>	26	19.5	5	3.5	8	36.8	67	G <sup>1</sup> / <sub>8</sub>	G <sup>1</sup> / <sub>8</sub>	M5	4.5	4.3	9	77
G <sup>1</sup> / <sub>4</sub>	32	24	6	3.5	9	38	70	G <sup>1</sup> / <sub>4</sub>	G <sup>1</sup> / <sub>8</sub>	M5	5.5	4.3	9	88

Pneumatic connection	H2	H3	H4	H5	H6	H7	H8	H15	H16	H17	L1	L2	L3
G <sup>1</sup> / <sub>8</sub>	41	21	38.5	22	19	42	12	242	129	262	47	40	43
G <sup>1</sup> / <sub>4</sub>	46	24	44	24	20	48	16	255	141.5	275	53	44	49

# Solenoid valves JMVH-B, Tiger 2000

Technical data – 5/2-way valves, double solenoid

Dimensions – Pneumatic connection G $\frac{3}{8}$

Download CAD data → [www.festo.com](http://www.festo.com)

Basic valve

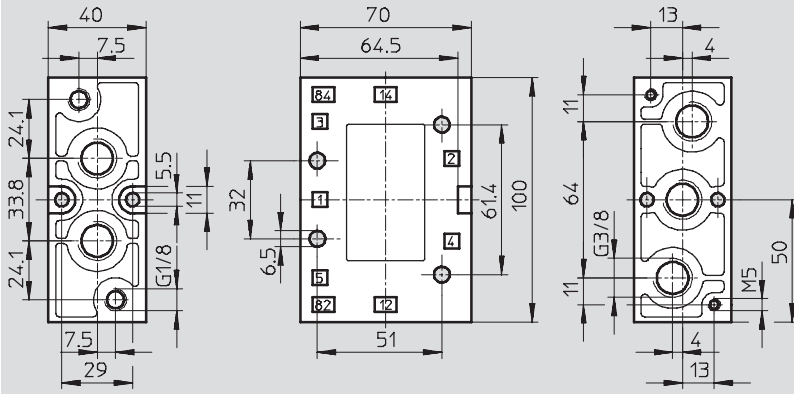

Installation dimensions with V solenoid coil, mechanical or pneumatic reset

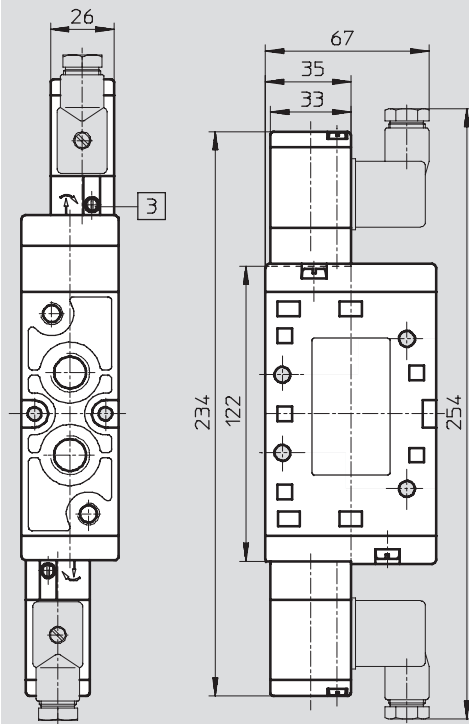

3 Manual override can be repositioned by 180°

# Solenoid valves JMVH-B, Tiger 2000

FESTO

Technical data – 5/2-way valves, double solenoid

Ordering data					
Circuit symbol	Solenoid coil	Voltage	Pneumatic connection	Part No.	Type
	With V solenoid coil, internal pilot air supply	24 V DC	G $\frac{1}{8}$	<b>30 475</b>	<b>JMVH-5-<math>\frac{1}{8}</math>-B</b>
			G $\frac{1}{4}$	<b>19 136</b>	<b>JMVH-5-<math>\frac{1}{4}</math>-B</b>
			G $\frac{3}{8}$	<b>14 948</b>	<b>JMVH-5-<math>\frac{3}{8}</math>-B</b>
	With V solenoid coil, external pilot air supply	24 V DC	G $\frac{1}{8}$	<b>30 476</b>	<b>JMVH-5-<math>\frac{1}{8}</math>-S-B</b>
			G $\frac{1}{4}$	<b>19 137</b>	<b>JMVH-5-<math>\frac{1}{4}</math>-S-B</b>
			G $\frac{3}{8}$	<b>15 343</b>	<b>JMVH-5-<math>\frac{3}{8}</math>-S-B</b>

Ordering data – Wearing parts kits		
Pneumatic connection	Part No.	Type
G $\frac{1}{8}$	<b>115 590</b>	<b>JMVH-5-<math>\frac{1}{8}</math>-B-(SB)</b>
G $\frac{1}{4}$	<b>115 589</b>	<b>JMVH-5-<math>\frac{1}{4}</math>-B-(SB)</b>



# Solenoid valves MVH-B, Tiger 2000

Technical data – 5/3-way valves

FESTO

-  - Flow rate  
1000 ... 2600 l/min

-  - Voltage  
24 V DC



General technical data					
Pneumatic connection		G $\frac{1}{8}$	G $\frac{1}{4}$	G $\frac{3}{8}$	
Valve function		5/3-way, single solenoid			
Constructional design		Piston spool			
Sealing principle		Soft			
Actuation type		Electrical			
Type of reset		Mechanical spring			
Type of pilot control		Piloted			
Pilot air supply		Internal or external			
Direction of flow		Non-reversible			
Exhaust function		With flow control			
Manual override		Resetting, detenting, covered			
Type of mounting		Via through-holes			
Mounting position		Any			
Nominal size		[mm]	5	7	12
Standard nominal flow rate	Closed	[l/min]	1000	1600	2000
	Exhausted	[l/min]			2200
	Pressurised	[l/min]			2600
Grid dimension		[mm]	27	33	41
Product weight		[g]	575	660	1000

Operating and environmental conditions					
Pneumatic connection		G $\frac{1}{8}$	G $\frac{1}{4}$	G $\frac{3}{8}$	
Operating medium		Filtered compressed air, lubricated or unlubricated Vacuum			
Operating pressure	Internal pilot air supply	[bar]	3 ... 10	3 ... 10	3 ... 10
	External pilot air supply	[bar]	-0.9 ... +10	-0.9 ... +10	-0.9 ... +10
Pilot pressure		[bar]	3 ... 10	3 ... 10	3 ... 10
Ambient temperature		[°C]	-5 ... +50		
Temperature of medium		[°C]	-5 ... +50		

# Solenoid valves MVH-B, Tiger 2000

Technical data – 5/3-way valves

FESTO

## Minimum pilot pressure $p_{12}/p_{14}$ as a function of the operating pressure $p_1$ (external pilot air supply)

MVH-5/3...-1/8-S-B

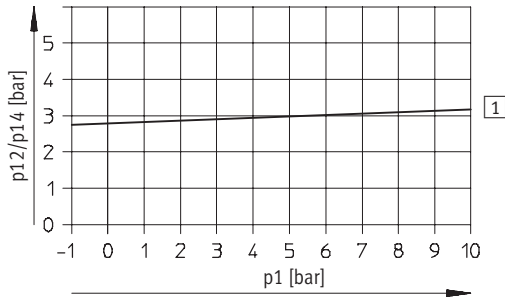

1 On

MVH-5/3...-1/4-S-B

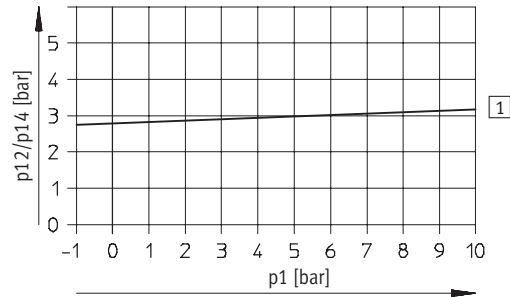

1 On

MVH-5/3...-3/8-S-B

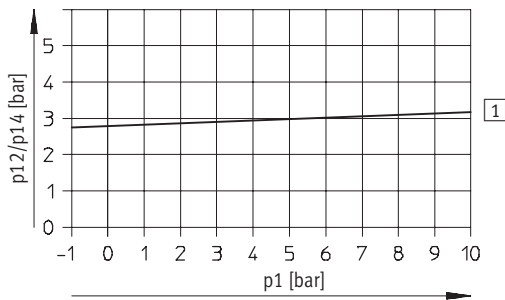

1 On

## Valve response times [ms]

Pneumatic connection	G <sup>1</sup> / <sub>8</sub>		G <sup>1</sup> / <sub>4</sub>		G <sup>3</sup> / <sub>8</sub>	
	On	Off	On	Off	On	Off
Closed	18	20	20	22	24	80
Exhausted	20	20	24	36	36	85
Pressurised	24	24	34	30	30	82

# Solenoid valves MVH-B, Tiger 2000

Technical data – 5/3-way valves

Electrical data			
V solenoid			
Electrical connection	To DIN EN 175301-803 type B		
Operating voltage	D.C. voltage	[V DC]	24
Coil characteristics	D.C. voltage	[W]	2.5
Protection class to EN 60 529	IP65 (in combination with plug socket)		

## Materials

Sectional view

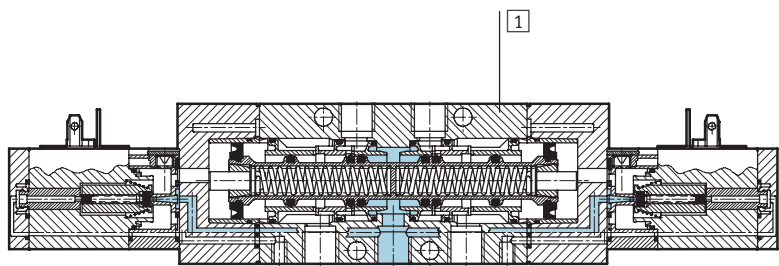

1	Housing	Die-cast aluminium, plastic
-	Seals	Nitrile rubber

# Solenoid valves MVH-B, Tiger 2000

Technical data – 5/3-way valves



## Dimensions – Pneumatic connection G $\frac{1}{8}$ , G $\frac{1}{4}$

Download CAD data → [www.festo.com](http://www.festo.com)

Basic valve

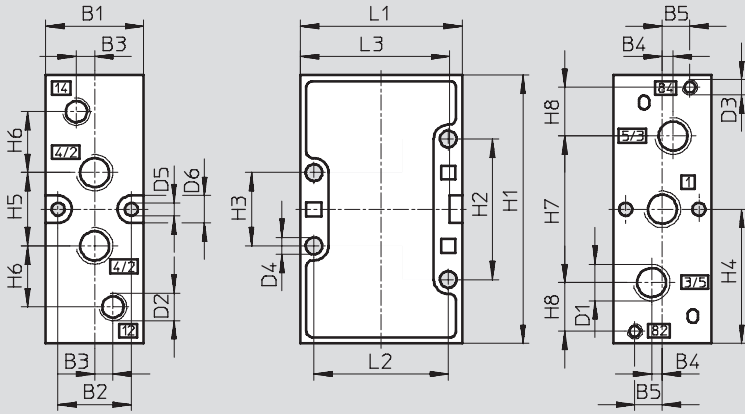

## Installation dimensions with V solenoid coil, mechanical or pneumatic reset

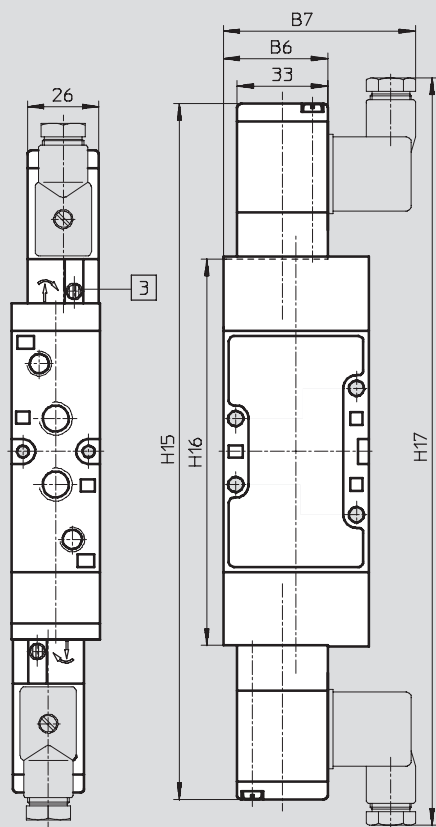

3 Manual override can be repositioned by 180°

Pneumatic connection	B1	B2	B3	B4	B5	B6	B7	D1	D2	D3	D4	D5	D6	H1
G $\frac{1}{8}$	26	19.5	5	3.5	8	36.8	67	G $\frac{1}{8}$	G $\frac{1}{8}$	M5	4.5	4.3	9	77
G $\frac{1}{4}$	32	24	6	3.5	9	38	70	G $\frac{1}{4}$	G $\frac{1}{8}$	M5	5.5	4.3	9	88

Pneumatic connection	H2	H3	H4	H5	H6	H7	H8	H15	H16	H17	L1	L2	L3
G $\frac{1}{8}$	41	21	38.5	22	19	42	12	242	129	262	47	40	43
G $\frac{1}{4}$	46	24	44	24	20	48	16	255	141.5	275	53	44	49

# Solenoid valves MVH-B, Tiger 2000

Technical data – 5/3-way valves

## Dimensions – Pneumatic connection G<sup>3</sup>/<sub>8</sub>

Download CAD data → [www.festo.com](http://www.festo.com)

Basic valve

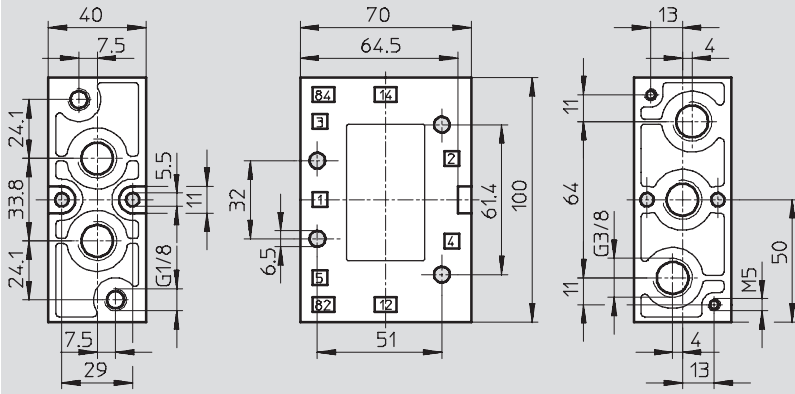

## Installation dimensions with V solenoid coil, mechanical or pneumatic reset

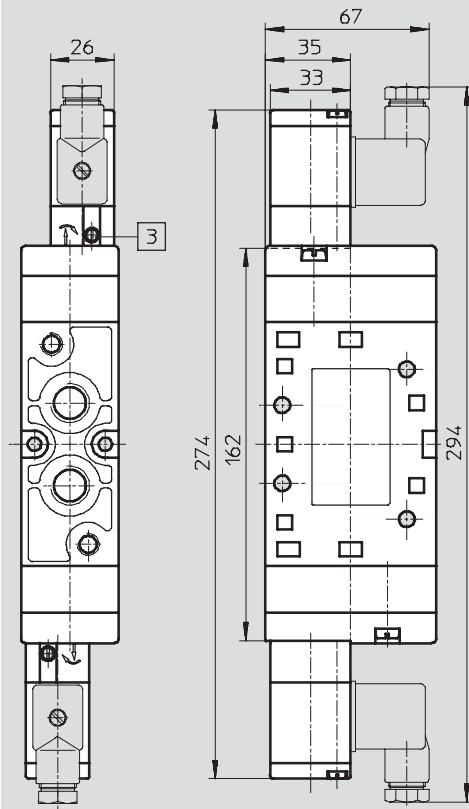

3 Manual override can be repositioned by 180°

# Solenoid valves MVH-B, Tiger 2000

Technical data – 5/3-way valves

Ordering data					
Circuit symbol	Description	Voltage	Pneumatic connection	Part No.	Type
	With V solenoid coil, normally closed, internal pilot air supply	24 V DC	G $\frac{1}{8}$	30 477	MVH-5/3G- $\frac{1}{8}$ -B
			G $\frac{1}{4}$	19 138	MVH-5/3G- $\frac{1}{4}$ -B
			G $\frac{3}{8}$	14 944	MVH-5/3G- $\frac{3}{8}$ -B
	With V solenoid coil, normally closed, external pilot air supply	24 V DC	G $\frac{1}{8}$	30 997	MVH-5/3G- $\frac{1}{8}$ -S-B
			G $\frac{1}{4}$	31 004	MVH-5/3G- $\frac{1}{4}$ -S-B
			G $\frac{3}{8}$	15 346	MVH-5/3G- $\frac{3}{8}$ -S-B
	With V solenoid coil, normally exhausted, internal pilot air supply	24 V DC	G $\frac{1}{8}$	30 478	MVH-5/3E- $\frac{1}{8}$ -B
			G $\frac{1}{4}$	19 139	MVH-5/3E- $\frac{1}{4}$ -B
			G $\frac{3}{8}$	14 943	MVH-5/3E- $\frac{3}{8}$ -B
	With V solenoid coil, normally exhausted, external pilot air supply	24 V DC	G $\frac{1}{8}$	30 998	MVH-5/3E- $\frac{1}{8}$ -S-B
			G $\frac{1}{4}$	31 005	MVH-5/3E- $\frac{1}{4}$ -S-B
			G $\frac{3}{8}$	15 344	MVH-5/3E- $\frac{3}{8}$ -S-B
	With V solenoid coil, normally pressurised, internal pilot air supply	24 V DC	G $\frac{1}{8}$	30 480	MVH-5/3B- $\frac{1}{8}$ -B
			G $\frac{1}{4}$	19 140	MVH-5/3B- $\frac{1}{4}$ -B
			G $\frac{3}{8}$	19 699	MVH-5/3B- $\frac{3}{8}$ -B
	With V solenoid coil, normally pressurised, external pilot air supply	24 V DC	G $\frac{1}{8}$	30 999	MVH-5/3B- $\frac{1}{8}$ -S-B
			G $\frac{1}{4}$	31 006	MVH-5/3B- $\frac{1}{4}$ -S-B
			G $\frac{3}{8}$	15 348	MVH-5/3B- $\frac{3}{8}$ -S-B

# Pneumatic valves, Tiger 2000

Peripherals overview

FESTO

## Mounting on manifold

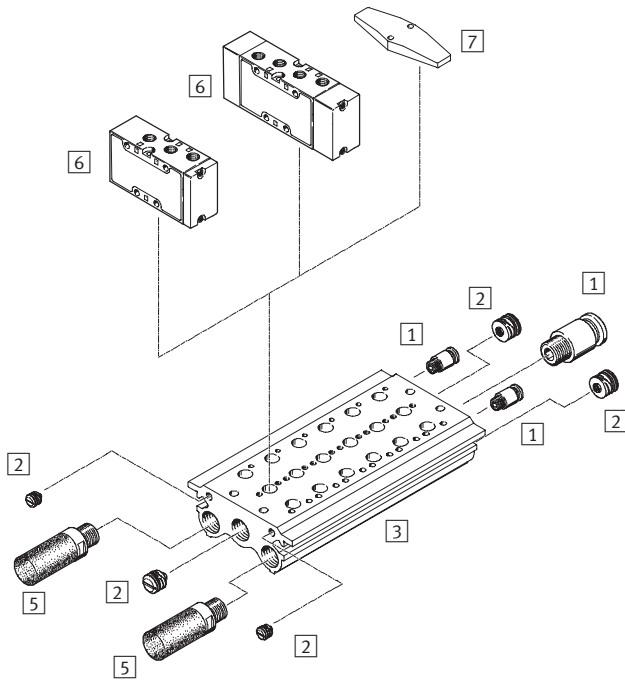

## Mounting on manifold strip

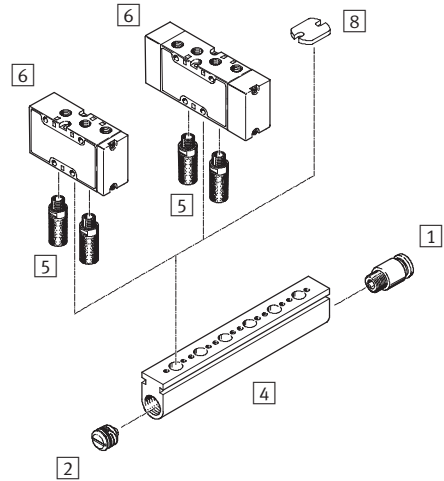

Accessories		Brief description	→ Page/Internet
1	Push-in fitting QS	For connecting compressed air tubing with standard O.D.	quick star
2	Sealing plug PRSV		64
3	Manifold PRS		62
4	Manifold strip PAL		60
5	Silencer	For fitting in exhaust ports	u
6	Pneumatic valve VL, J		5
7	Blanking plate PRSB	For covering vacant positions	64
8	Blanking plate PALB	For covering vacant positions	64

# Pneumatic valves, Tiger 2000

Type code

FESTO

		VL	-	5/3	G	-	1/8	-	B
<b>Type</b>									
VL	Single pilot								
J	Double pilot								
<b>Valve function</b>									
5	5/2-way valve								
5/3	5/3-way valve								
<b>Normal position</b>									
G	Closed								
E	Exhausted								
B	Pressurised								
<b>Pneumatic connection</b>									
1/8	G1/8								
1/4	G1/4								
3/8	G3/8								
<b>Generation</b>									
B	Series B								



# Pneumatic valves VL, Tiger 2000

Technical data – 5/2-way valves

-  - Flow rate  
750 ... 2000 l/min

Wearing parts kits  
→ 52



General technical data			
Pneumatic connection	G1/8	G1/4	G3/8
Valve function	5/2-way, single pilot		
Constructional design	Poppet		Piston spool
Sealing principle	Soft		
Actuation type	Pneumatic		
Type of reset	Mechanical spring		
Type of pilot control	Direct		
Direction of flow	Non-reversible		Reversible
Exhaust function	With flow control		
Manual override	None		
Type of mounting	Via through-holes		
Mounting position	Any		
Nominal size [mm]	5	7	12
Standard nominal flow rate [l/min]	750	1300	2000
Grid dimension [mm]	27	33	41
Product weight [g]	170	240	570

Operating and environmental conditions			
Pneumatic connection	G1/8	G1/4	G1/4
Operating medium	Filtered compressed air, lubricated or unlubricated Vacuum		
Operating pressure [bar]	0 ... 10	0 ... 10	-0.9 ... +10
Pilot pressure [bar]	1.5 ... 10	1.5 ... 10	2 ... 10
Ambient temperature [°C]	-10 ... +60		
Temperature of medium [°C]	-10 ... +60		

# Pneumatic valves VL, Tiger 2000

Technical data – 5/2-way valves

FESTO

## Minimum pilot pressure $p_{12}$ , $p_{14}$ as a function of the operating pressure $p_1$

VL-5-1/8-B

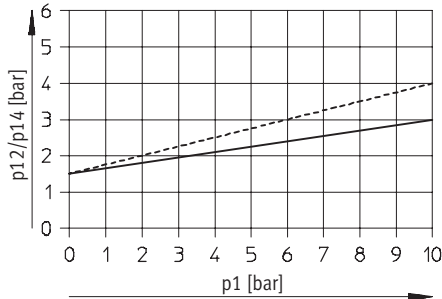

----- Exhaust throttled  
 ———— Exhaust unthrottled

VL-5-1/4-B

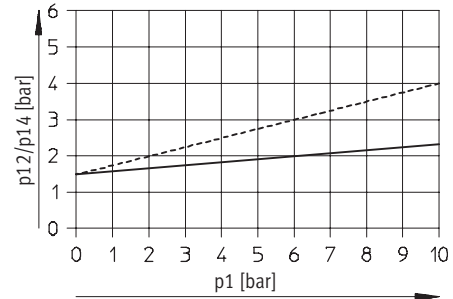

----- Exhaust throttled  
 ———— Exhaust unthrottled

VL-5-3/8-B

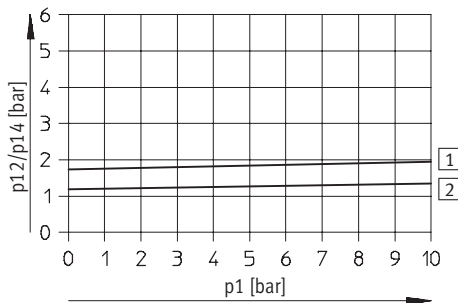

1 On  
 2 Off

## Valve response times [ms]

Pneumatic connection	G1/8	G1/4	G3/8
On	2	2	4
Off	10	12	16

## Materials

Sectional view

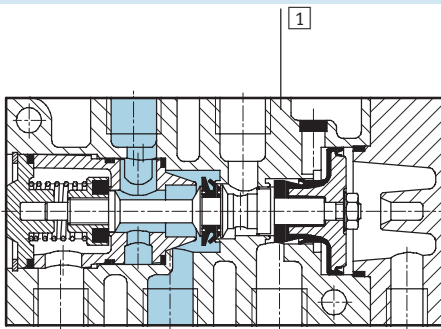

1	Housing	Die-cast aluminium
-	Seals	Nitrile rubber

# Pneumatic valves VL, Tiger 2000

Technical data – 5/2-way valves



## Dimensions – Pneumatic connection G $\frac{1}{8}$ , G $\frac{1}{4}$

Download CAD data → [www.festo.com](http://www.festo.com)

Basic valve

VL-5-...-B

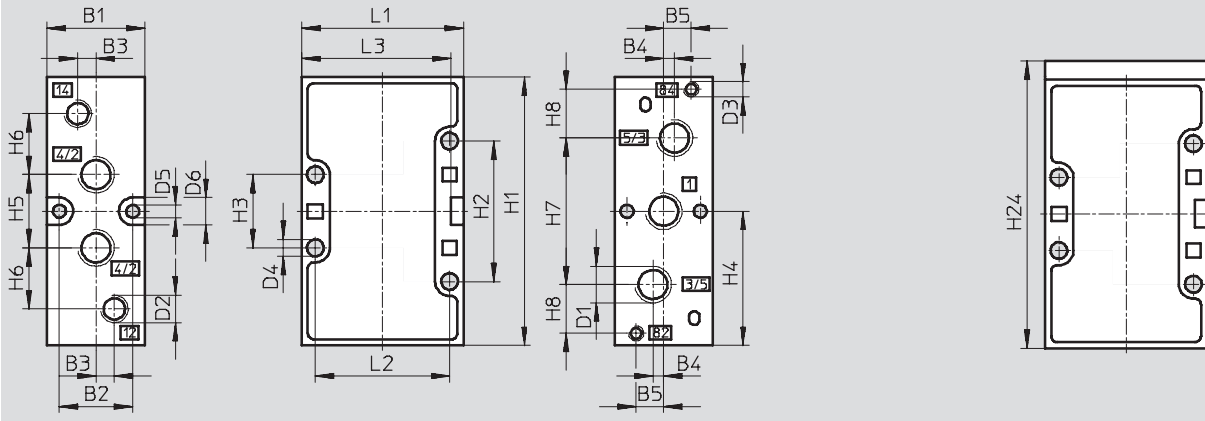

Pneumatic connection	B1	B2	B3	B4	B5	D1	D2	D3	D4	D5	D6	H1
G $\frac{1}{8}$	26	19.5	5	3.5	8	G $\frac{1}{8}$	G $\frac{1}{8}$	M5	4.5	4.3	9	77
G $\frac{1}{4}$	32	24	6	3.5	9	G $\frac{1}{4}$	G $\frac{1}{8}$	M5	5.5	4.3	9	88

Pneumatic connection	H2	H3	H4	H5	H6	H7	H8	H24	L1	L2	L3
G $\frac{1}{8}$	41	21	38.5	22	19	42	12	83	47	40	43
G $\frac{1}{4}$	46	24	44	24	20	48	16	94	53	44	49

## Dimensions – Pneumatic connection G $\frac{3}{8}$

Download CAD data → [www.festo.com](http://www.festo.com)

Basic valve

VL-5- $\frac{3}{8}$ -B

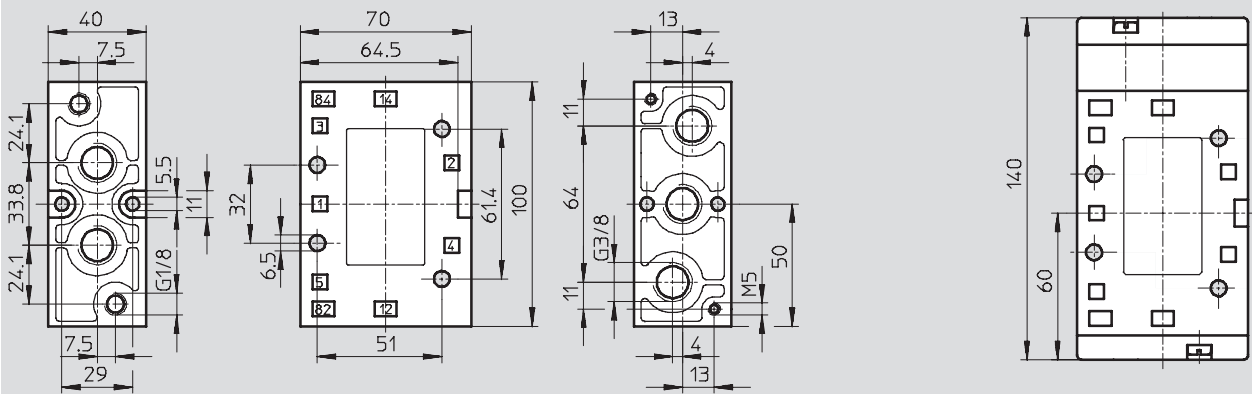

# Pneumatic valves VL, Tiger 2000

Technical data – 5/2-way valves

Ordering data				
Circuit symbol	Description	Pneumatic connection	Part No.	Type
	Mechanical reset	G1/8	31 000	VL-5-1/8-B
		G1/4	14 294	VL-5-1/4-B
		G3/8	14 952	VL-5-3/8-B

Ordering data – Wearing parts kits		
Pneumatic connection	Part No.	Type
G1/8	125 710	VL-5-1/8-B
G1/4	115 580	VL-5-1/4-B

# Pneumatic valves J, Tiger 2000

Technical data – 5/2-way valves, double pilot

FESTO

-  - Flow rate  
800 ... 2000 l/min



General technical data				
Pneumatic connection	G $\frac{1}{8}$	G $\frac{1}{4}$	G $\frac{3}{8}$	
Valve function	5/2-way, double pilot			
Constructional design	Piston spool			
Sealing principle	Soft			
Actuation type	Pneumatic			
Type of pilot control	Direct			
Direction of flow	Reversible			
Exhaust function	With flow control			
Manual override	None			
Type of mounting	Via through-holes			
Mounting position	Any			
Nominal size	[mm]	8	10	12
Standard nominal flow rate	[l/min]	800	1600	2000
Grid dimension	[mm]	27	33	41
Product weight	[g]	320	375	550

Operating and environmental conditions				
Pneumatic connection	G $\frac{1}{8}$	G $\frac{1}{4}$	G $\frac{1}{4}$	
Operating medium	Filtered compressed air, lubricated or unlubricated Vacuum			
Operating pressure	[bar]	-0.9 ... +10	-0.9 ... +10	-0.9 ... +10
Pilot pressure	[bar]	3 ... 10	3 ... 10	3 ... 10
Ambient temperature	[°C]	-10 ... +60		
Temperature of medium	[°C]	-10 ... +60		

# Pneumatic valves J, Tiger 2000

Technical data – 5/2-way valves, double pilot

FESTO

## Minimum pilot pressure $p_{12}/p_{14}$ as a function of the operating pressure $p_1$

J-5-3/8-B

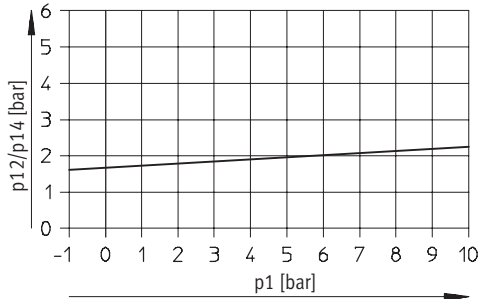

J-5-1/4-B

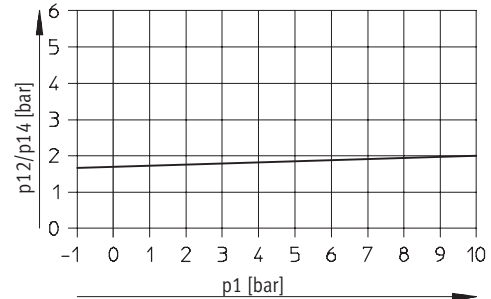

J-5-3/8-B

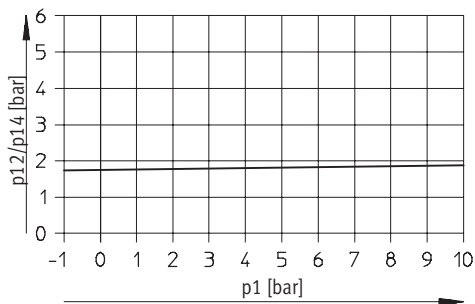

## Valve response times [ms]

Pneumatic connection	G1/8	G1/4	G3/8
Changeover	3	3	3

## Materials

Sectional view

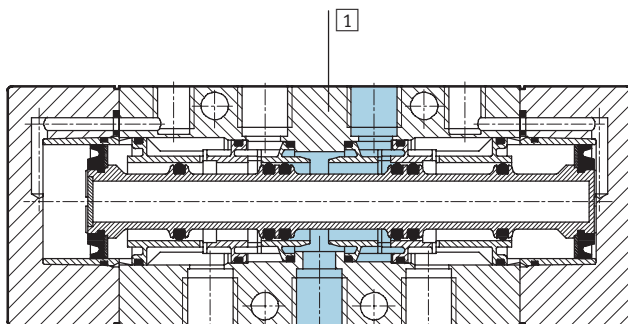

1	Housing	Die-cast aluminium
-	Seals	Nitrile rubber

# Pneumatic valves J, Tiger 2000

Technical data – 5/2-way valves, double pilot



**Dimensions – Pneumatic connection G<sup>1</sup>/<sub>8</sub>, G<sup>1</sup>/<sub>4</sub>** Download CAD data → [www.festo.com](http://www.festo.com)  
 Basic valve J-5-...-B

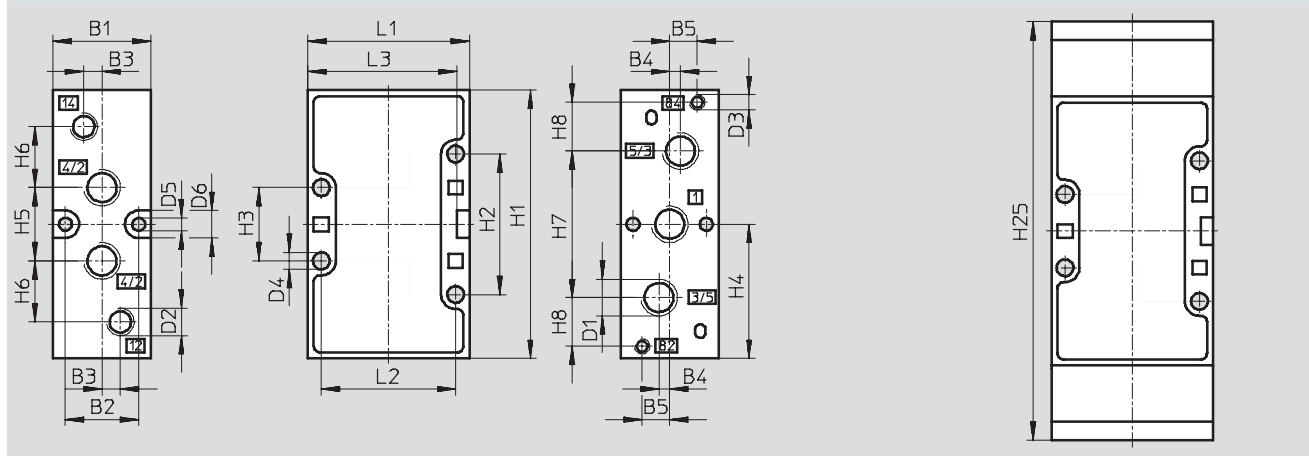

Pneumatic connection	B1	B2	B3	B4	B5	D1	D2	D3	D4	D5	D6	H1
G <sup>1</sup> / <sub>8</sub>	26	19.5	5	3.5	8	G <sup>1</sup> / <sub>8</sub>	G <sup>1</sup> / <sub>8</sub>	M5	4.5	4.3	9	77
G <sup>1</sup> / <sub>4</sub>	32	24	6	3.5	9	G <sup>1</sup> / <sub>4</sub>	G <sup>1</sup> / <sub>8</sub>	M5	5.5	4.3	9	88

Pneumatic connection	H2	H3	H4	H5	H6	H7	H8	H25	L1	L2	L3
G <sup>1</sup> / <sub>8</sub>	41	21	38.5	22	19	42	12	124	47	40	43
G <sup>1</sup> / <sub>4</sub>	46	24	44	24	20	48	16	137	53	44	49

**Dimensions – Pneumatic connection G<sup>3</sup>/<sub>8</sub>** Download CAD data → [www.festo.com](http://www.festo.com)  
 Basic valve J-5-<sup>3</sup>/<sub>8</sub>-B

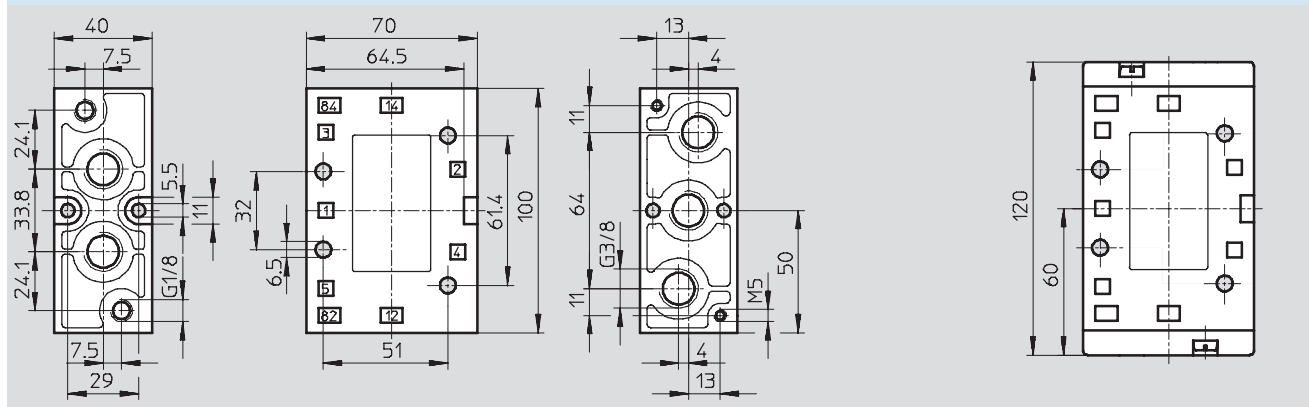

Ordering data			
Circuit symbol	Pneumatic connection	Part No.	Type
	G <sup>1</sup> / <sub>8</sub>	30 988	J-5- <sup>1</sup> / <sub>8</sub> -B
	G <sup>1</sup> / <sub>4</sub>	14 295	J-5- <sup>1</sup> / <sub>4</sub> -B
	G <sup>3</sup> / <sub>8</sub>	14 953	J-5- <sup>3</sup> / <sub>8</sub> -B

# Pneumatic valves VL, Tiger 2000

FESTO

Technical data – 5/3-way valves

-  - Flow rate  
800 ... 2000 l/min



General technical data			
Pneumatic connection	G1/8	G1/4	G3/8
Valve function	5/3-way, single pilot		
Constructional design	Piston spool		
Sealing principle	Soft		
Actuation type	Pneumatic		
Type of reset	Mechanical spring		
Type of pilot control	Direct		
Direction of flow	Reversible		
Exhaust function	With flow control		
Manual override	None		
Type of mounting	Via through-holes		
Mounting position	Any		
Nominal size [mm]	8	10	12
Standard nominal flow rate [l/min]	800	1600	2000
Grid dimension [mm]	27	33	41
Product weight [g]	320	375	680

Operating and environmental conditions			
Pneumatic connection	G1/8	G1/4	G3/8
Operating medium	Filtered compressed air, lubricated or unlubricated Vacuum		
Operating pressure [bar]	-0.9 ... +10	-0.9 ... +10	-0.9 ... +10
Pilot pressure [bar]	3 ... 10	3 ... 10	3 ... 10
Ambient temperature [°C]	-10 ... +60		
Temperature of medium [°C]	-10 ... +60		



# Pneumatic valves VL, Tiger 2000

Technical data – 5/3-way valves

## Minimum pilot pressure $p_{12}/p_{14}$ as a function of the operating pressure $p_1$

VL-5/3...-1/8-B

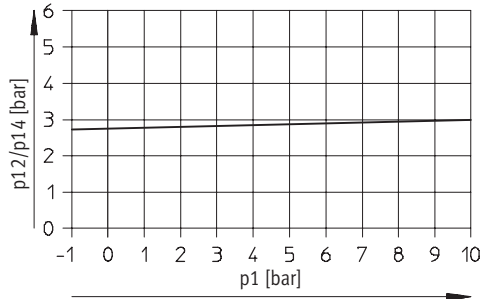

VL-5/3...-1/4-B

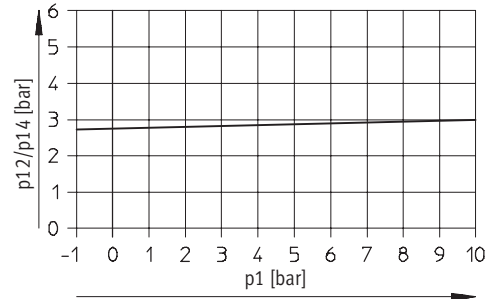

VL-5/3...-3/8-B

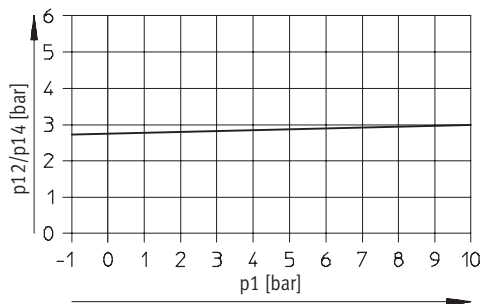

## Valve response times [ms]

Pneumatic connection	G1/8	G1/4	G3/8
On	5	6	7
Off	14	26	28

## Materials

Sectional view

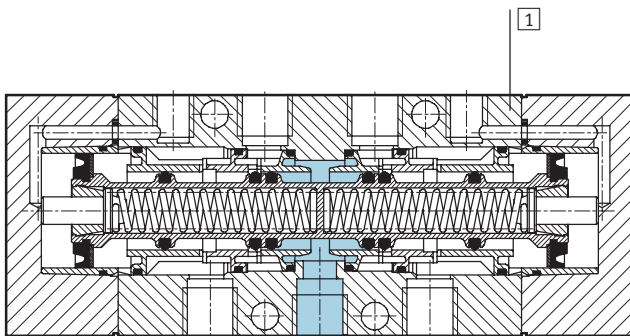

1	Housing	Die-cast aluminium
-	Seals	Nitrile rubber

# Pneumatic valves VL, Tiger 2000

Technical data – 5/3-way valves



## Dimensions – Pneumatic connection G $\frac{1}{8}$ , G $\frac{1}{4}$

Download CAD data → [www.festo.com](http://www.festo.com)

Basic valve

J-5- ... -B

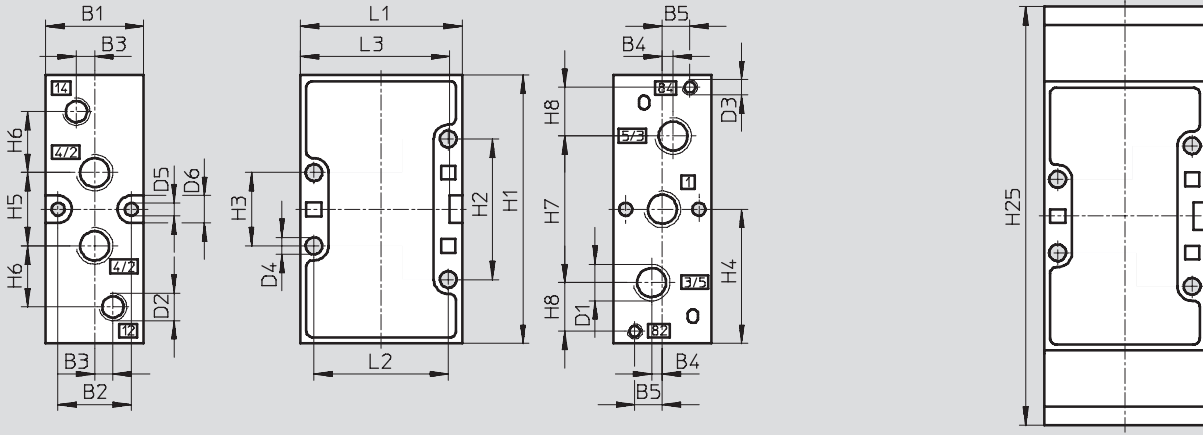

Pneumatic connection	B1	B2	B3	B4	B5	D1	D2	D3	D4	D5	D6	H1
G $\frac{1}{8}$	26	19.5	5	3.5	8	G $\frac{1}{8}$	G $\frac{1}{8}$	M5	4.5	4.3	9	77
G $\frac{1}{4}$	32	24	6	3.5	9	G $\frac{1}{4}$	G $\frac{1}{8}$	M5	5.5	4.3	9	88

Pneumatic connection	H2	H3	H4	H5	H6	H7	H8	H25	L1	L2	L3
G $\frac{1}{8}$	41	21	38.5	22	19	42	12	124	47	40	43
G $\frac{1}{4}$	46	24	44	24	20	48	16	137	53	44	49

## Dimensions – Pneumatic connection G $\frac{3}{8}$

Download CAD data → [www.festo.com](http://www.festo.com)

Basic valve

VL-5/3...- $\frac{3}{8}$ -B

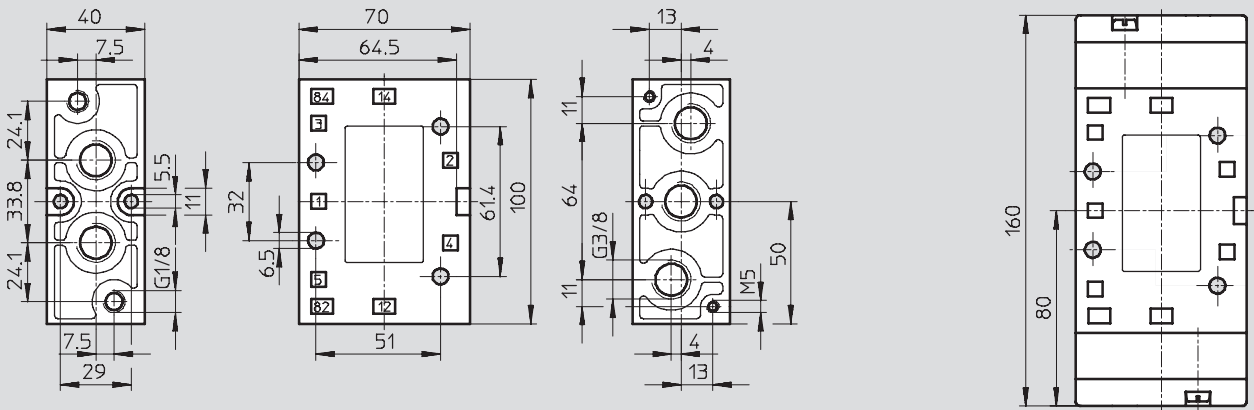

# Pneumatic valves VL, Tiger 2000

Technical data – 5/3-way valves

Ordering data				
Circuit symbol	Description	Pneumatic connection	Part No.	Type
	Normally closed	G $\frac{1}{8}$	30 990	VL-5/3G- $\frac{1}{8}$ -B
		G $\frac{1}{4}$	14 298	VL-5/3G- $\frac{1}{4}$ -B
		G $\frac{3}{8}$	14 950	VL-5/3G- $\frac{3}{8}$ -B
	Normally exhausted	G $\frac{1}{8}$	31 309	VL-5/3E- $\frac{1}{8}$ -B
		G $\frac{1}{4}$	14 297	VL-5/3E- $\frac{1}{4}$ -B
		G $\frac{3}{8}$	14 949	VL-5/3E- $\frac{3}{8}$ -B
	Normally pressurised	G $\frac{1}{8}$	31 310	VL-5/3B- $\frac{1}{8}$ -B
		G $\frac{1}{4}$	14 298	VL-5/3B- $\frac{1}{4}$ -B
		G $\frac{3}{8}$	14 951	VL-5/3B- $\frac{3}{8}$ -B

# Solenoid/pneumatic valves, Tiger 2000

Accessories

FESTO

## Manifold strip

PAL-...-B

Material:

Anodised aluminium

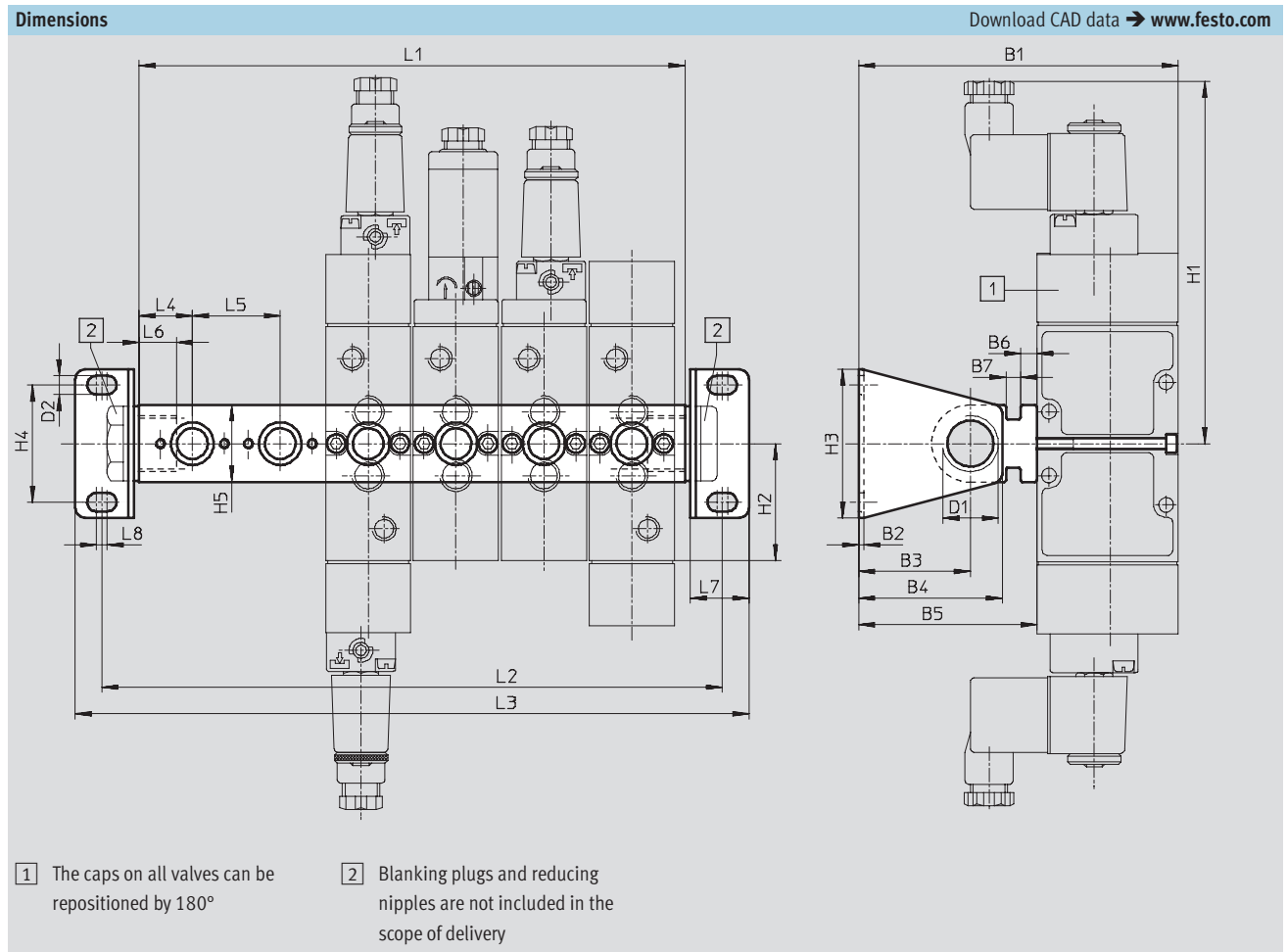
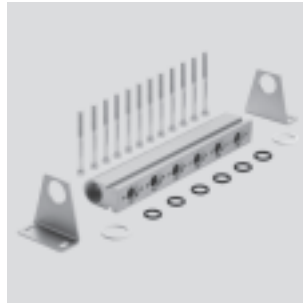

Type	B1	B2	B3	B4	B5	B6	B7	D1	D2	H1	H2	H3	H4	L4	L5	L6	L7	L8
PAL-1/8-...	104	2	33.5	44.5	57	5	5.5	G3/8	5.2	130	38.5	44	32	18	27	12	20	4
PAL-1/4-...	120	2	42	54	67	6.1	5.5	G1/2	7	136	44	56	44	20	33	14	22	4
PAL-3/8-...	176	3	75	93	106	4	14	G3/4	9	147	50	80	60	25	41	17	30	5

# Solenoid/pneumatic valves, Tiger 2000

FESTO

Accessories

Dimensions and ordering data						
Number of valve ports	L1	L2	L3	Weight [g]	Part No.	Type
Pneumatic connection G $\frac{1}{8}$						
2	63	89	107	150	30 552	PAL- $\frac{1}{8}$ -2-B
3	90	116	134	190	30 553	PAL- $\frac{1}{8}$ -3-B
4	117	143	161	230	30 554	PAL- $\frac{1}{8}$ -4-B
5	144	170	188	260	30 555	PAL- $\frac{1}{8}$ -5-B
6	171	197	215	290	30 556	PAL- $\frac{1}{8}$ -6-B
7	198	224	242	340	30 557	PAL- $\frac{1}{8}$ -7-B
8	225	251	269	370	30 558	PAL- $\frac{1}{8}$ -8-B
9	252	278	296	410	30 559	PAL- $\frac{1}{8}$ -9-B
10	279	305	323	450	30 560	PAL- $\frac{1}{8}$ -10-B
Pneumatic connection G $\frac{1}{4}$						
2	73	101	121	230	30 280	PAL- $\frac{1}{4}$ -2-B
3	106	134	154	290	30 281	PAL- $\frac{1}{4}$ -3-B
4	139	167	187	350	30 282	PAL- $\frac{1}{4}$ -4-B
5	172	200	220	420	30 283	PAL- $\frac{1}{4}$ -5-B
6	205	233	253	480	30 284	PAL- $\frac{1}{4}$ -6-B
7	238	266	286	540	30 285	PAL- $\frac{1}{4}$ -7-B
8	271	299	319	600	30 286	PAL- $\frac{1}{4}$ -8-B
9	304	322	352	660	30 287	PAL- $\frac{1}{4}$ -9-B
10	337	365	385	730	30 288	PAL- $\frac{1}{4}$ -10-B
Pneumatic connection G $\frac{3}{8}$						
2	91	127	155	510	30 692	PAL- $\frac{3}{8}$ -2-B
3	132	168	196	610	30 693	PAL- $\frac{3}{8}$ -3-B
4	173	209	237	720	30 694	PAL- $\frac{3}{8}$ -4-B
5	214	250	278	830	30 695	PAL- $\frac{3}{8}$ -5-B
6	255	291	319	960	30 696	PAL- $\frac{3}{8}$ -6-B
7	296	332	360	1060	30 697	PAL- $\frac{3}{8}$ -7-B
8	337	373	401	1160	30 698	PAL- $\frac{3}{8}$ -8-B
9	378	414	442	1260	30 699	PAL- $\frac{3}{8}$ -9-B
10	419	455	483	1360	30 680	PAL- $\frac{3}{8}$ -10-B

# Solenoid/pneumatic valves, Tiger 2000

Accessories

FESTO

Manifold  
PRS

Material:  
Anodised aluminium

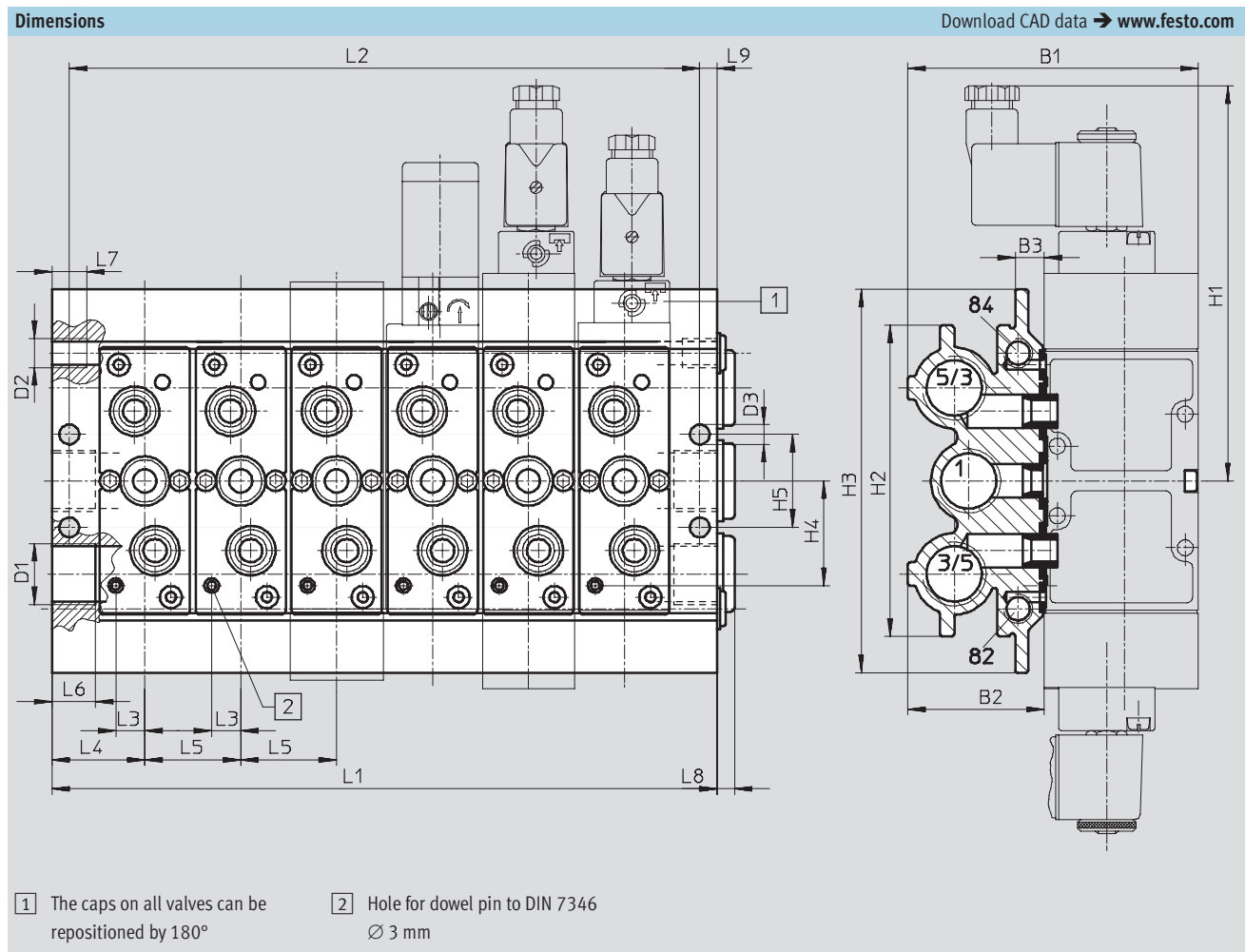

Type	B1	B2	B3	D1	D2	D3	H1	H2	H3	H4	H5	L3	L4	L5	L6	L7	L8	L9
PRS-1/8-...	93	45.5	11.2	G3/8	G1/8	6.8	130	95	120	27	27.5	9.4	25.5	27	14	8	5	6
PRS-1/4-...	100	47	10	G1/2	G1/8	6.8	136	107	132	36	32	10	32	33	15	12	6	9
PRS-3/8-...	131	60.5	12.5	G3/4	G1/8	9	147	128	153	44	44	15.2	36.5	41	16	12	6	7.5

# Solenoid/pneumatic valves, Tiger 2000

FESTO

Accessories

Dimensions and ordering data					
Number of valve ports	L1	L2	Weight [g]	Part No.	Type
Pneumatic connection G $\frac{1}{8}$					
2	78	66	700	30 542	PRS- $\frac{1}{8}$ -2-BB
3	105	93	920	30 543	PRS- $\frac{1}{8}$ -3-BB
4	132	120	1150	30 544	PRS- $\frac{1}{8}$ -4-BB
5	159	147	1320	30 545	PRS- $\frac{1}{8}$ -5-BB
6	186	174	1520	30 546	PRS- $\frac{1}{8}$ -6-BB
7	213	201	1750	30 547	PRS- $\frac{1}{8}$ -7-BB
8	240	228	2010	30 548	PRS- $\frac{1}{8}$ -8-BB
9	267	255	2200	30 549	PRS- $\frac{1}{8}$ -9-BB
10	294	282	2400	30 550	PRS- $\frac{1}{8}$ -10-BB
Pneumatic connection G $\frac{1}{4}$					
2	97	85	1050	15 861	PRS- $\frac{1}{4}$ -2-B
3	130	118	1310	15 862	PRS- $\frac{1}{4}$ -3-B
4	163	151	1610	15 863	PRS- $\frac{1}{4}$ -4-B
5	196	184	1900	15 864	PRS- $\frac{1}{4}$ -5-B
6	229	217	2200	15 865	PRS- $\frac{1}{4}$ -6-B
7	262	250	2500	15 866	PRS- $\frac{1}{4}$ -7-B
8	259	283	2800	15 867	PRS- $\frac{1}{4}$ -8-B
9	328	316	3100	15 868	PRS- $\frac{1}{4}$ -9-B
10	361	349	3360	30 289	PRS- $\frac{1}{4}$ -10-B
Pneumatic connection G $\frac{3}{8}$					
2	114	99	1600	30 682	PRS- $\frac{3}{8}$ -2-B
3	155	140	2100	30 683	PRS- $\frac{3}{8}$ -3-B
4	196	181	2630	30 684	PRS- $\frac{3}{8}$ -4-B
5	237	222	3100	30 685	PRS- $\frac{3}{8}$ -5-B
6	278	263	3500	30 686	PRS- $\frac{3}{8}$ -6-B
8	360	345	4620	30 688	PRS- $\frac{3}{8}$ -8-B
10	442	427	5600	30 680	PRS- $\frac{3}{8}$ -10-B

# Solenoid/pneumatic valves, Tiger 2000

Accessories

FESTO

## Blanking plate for vacant positions PRSB

Material:  
Die-cast aluminium



Ordering data			
Pneumatic connection	Weight [g]	Part No.	Type
G $\frac{1}{8}$	33	15 909	PRBS- $\frac{1}{8}$ -B
G $\frac{1}{4}$	40	30 666	PRSB- $\frac{1}{4}$ -B
G $\frac{3}{8}$	72	30 681	PRSB- $\frac{3}{8}$ -B

## Blanking plate for vacant positions PALB

Material:  
Steel



Ordering data			
Pneumatic connection	Weight [g]	Part No.	Type
G $\frac{1}{8}$	14	30 903	PALB- $\frac{1}{8}$ -B
G $\frac{1}{4}$	22	30 904	PALB- $\frac{1}{4}$ -B
G $\frac{3}{8}$	32	30 905	PALB- $\frac{3}{8}$ -B

## Sealing plug PRSV

Material:  
Steel



Ordering data			
Pneumatic connection	Weight [g]	Part No.	Type
G $\frac{1}{8}$	18	160 997	PRSV- $\frac{1}{8}$ -B
G $\frac{1}{4}$	27	160 996	PRSV- $\frac{1}{4}$ -B



# Solenoid/pneumatic valves, Tiger 2000

Accessories

FESTO

## Manual override tool AHB

Material:  
Polymer

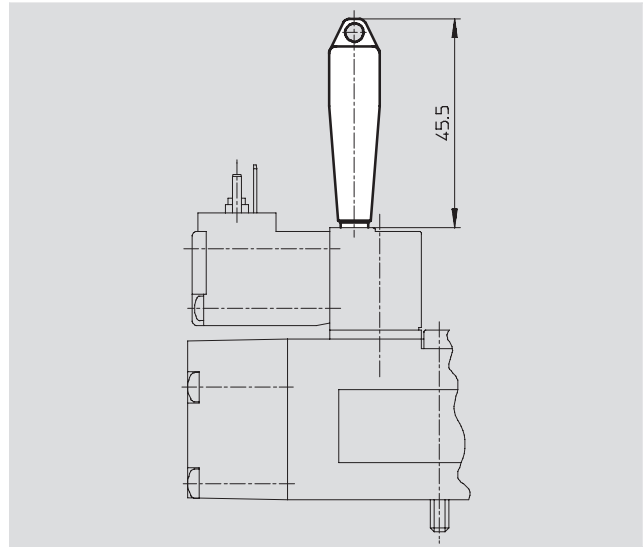

Ordering data				
For valve	Weight [g]	CRC <sup>1)</sup>	Part No.	Type
MFH/JMFH	10	2	157 651	AHB-MD/MF/MV

1) Corrosion resistance class 2 according to Festo standard 940 070

Components requiring moderate corrosion resistance. Externally visible parts with primarily decorative surface requirements which are in direct contact with a surrounding industrial atmosphere or media such as cooling or lubricating agents.

## Inscription labels KMC/F/V-BZ-35X

Material:  
Polymer

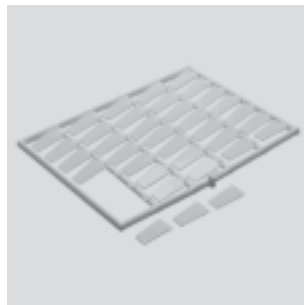



Ordering data			
	Weight [g]	Part No.	Type
Inscription labels for valves (35 in frames included in scope of delivery)	20	33 362	KMC/F/V-BZ-35x

Ordering data – Solenoid coils			Technical data → Internet: msf	
	Voltage	Cable length [m]	Part No.	Type
F solenoid coils for valves MFH, JMFH				
	12 V DC	–	34 410	MSFG-12DC-OD
	24 V DC and 42 V AC, 50 ... 60 Hz	–	34 411	MSFG-24DC/42AC-OD
	42 V DC	–	34 413	MSFG-42DC-OD
	24 V AC	–	34 415	MSFG-24AC-OD
	48 V AC, 50 ... 60 Hz	–	34 418	MSFW-48AC-OD
	110 V AC, 50 ... 60 Hz and 120 V AC, 60 Hz	–	34 420	MSFW-110AC-OD
	230 V AC, 50 ... 60 Hz and 240 V AC, 60 Hz	–	34 422	MSFW-230AC-OD
	240 V AC, 50 ... 60 Hz	–	34 424	MSFW-240AC-OD



# Solenoid/pneumatic valves, Tiger 2000

Accessories

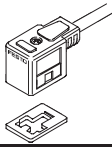
FESTO

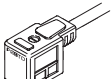
Ordering data – Plug sockets, plug sockets with cable for F solenoid coils					
	Voltage	Cable length [m]	Switching status display with LED	Part No.	Type
Plug socket without cable					Technical data → Internet: mssd
	–	–	–	34 431	MSSD-F
	–	–	–	539 710	MSSD_F-M16
Plug socket without cable with insulation displacement technology					Technical data → Internet: mssd
	–	–	–	192 746	MSSD-F-S-M16
Plug socket with cable					Technical data → Internet: kmf
	24 V DC	2.5	■	30 935	KMF-1-24DC-2,5-LED
		5	■	30 937	KMF-1-24DC-5-LED
		10	■	193 458	KMF-1-24DC-10-LED
	Up to 240 V	2.5	–	30 936	KMF-1-230AC-2,5
		5	–	30 938	KMF-1-230AC-5

Ordering data – Plug sockets, plug sockets with cable for V solenoid coils					
	Voltage	Cable length [m]	Switching status display with LED	Part No.	Type
Plug socket without cable					Technical data → Internet: mssd
	–	–	–	33 295	MSSD-V
	–	–	–	539 713	MSSD-V-M16
Plug socket with cable					Technical data → Internet: kmv
	24 V DC	2.5	■	30 939	KMV-1-24DC-2,5-LED
		5	■	30 941	KMV-1-24DC-5-LED
		10	■	193 456	KMV-1-24-10-LED

Ordering data – Illuminating seal				Technical data → Internet: illuminating seal	
	Voltage			Part No.	Type
For F solenoid coils					
	12 ... 24 V DC			19 143	MF-LD-12-24DC
	230 V DC/V AC			19 144	MF-LD-230AC
For V solenoid coils					
	12 ... 24 V DC			35 558	MV-LD-12-24DC